

A

**HAND BOOK
OF
SCHOOL EDUCATION
&
ALLIED STATISTICS**

NIEPA DC



D09470

**MINISTRY OF HUMAN RESOURCE DEVELOPMENT
DEPARTMENT OF EDUCATION
(PLANNING, MONITORING & STATISTICS DIVISION)
GOVERNMENT OF INDIA
NEW DELHI**

LIBRARY & DOCUMENTATION DEPT.
National Institute of Education
Planning and Administration.
17-B, Sri Aurobindo Marg,
New Delhi-110016
DOC, No D-9470
Date 09-04-97

PREFACE

This is the Fourth issue of the publication "A Hand Book of Educational and Allied Statistics, the first one was brought by the Ministry of Human Resource Development in 1980. The main objective of bringing out this publication is to make available the latest data on Education and related sectors like Population, Literacy, etc. for the benefit of various users of educational data viz. Planners, Administrators and Research workers.

The publication provides time series data on Education for All India covering the period 1950-51 to 1994-95 and State-wise data for the Years 1980-81 and 1990-91. .ls 2

The work relating collection of data in respect of affiliated institutions was transferred to U.G.C. w.e.f. from 1987-88 and U.G.C. has since not been able to bring out statistics relating to Higher Education, it has not been possible to update relevant information. Therefore the publication has been restricted to school education only.

The Ministry of Human Resource Development, Department of Education thanks the Registrar General of India. The Ministry also expresses its thanks to all the Ministries and other organisations from whose publication Secondary data have been reported in the publication.

I am grateful to Dr. R S Thakur Joint Director (P) in this Ministry for his dedicated efforts in overall supervision of the data collection, its compilation and for editing the final manuscript, I also share my gratitude to the other staff of the Statistical and CMIS Units of the Ministry for their sincere efforts in bringing out this publication.

Based on suggestions made by some of the User Organisations, we have slightly revised the Fourth issue so as to make it more useful to all the users of this publication. However, further suggestions to improve the publication are most welcome and may be sent to the Joint Secretary (Planning), Ministry of Human Resource Development, Department of Education, New Delhi.

New Delhi,
the April, 1996

Bhaskar Chatterjee
Joint Secretary,
Department of Education
Ministry of Human
Resource Development,
Government of India.

P R O J E C T S T A F F

Dr R. S. THAKUR	JOINT DIRECTOR (PLG)
SHRI S S MALKANI	ASSTT. EDUCATION OFFICER
SHRI R. B. TRIPATHI	SENIOR INVESTIGAROR
SMT. RENU WALIA	COMPUTER

C O M P U T E R S T A F F

SHRI OM PRAKASH	PROGRAMMER
SHRI V. NAGARAJAN, W.P.O.	WORD PROCESSOR OPERATOR
SHRI KRISHANA KUMAR	WORD PROCESSOR OPERATOR
MRS ASHA KHURANA	K.P.O.
MRS CHANDER KANTA	K.P.O.
MRS PUSHPA BISHT	K.P.O.

INTRODUCTION

Educational Planners, Administrators and various Research Workers in the field of education have been finding it difficult to get different types of educational statistics in a single publication giving overall picture in the field of education. Besides, to evaluate the performance of educational system and to formulate programme, time series data may prove very useful. The present publication covers important statistics in the field of education and related sectors. Various types of data available in this publication are explained below for the benefit of the users of this publication.

1. Demographic Data

Tables 1.1 to 1.12 give data on area, population density, All India population estimates for the total population and for the age- group 6-11 Years, 11-13 Years, 14-15 & 16-17 Years for the period 1981-2000 have been included in these tables. These estimates have been supplied by the Registrar General's Office. Statewise estimated population in the age- groups 6-10, 11-13, 14-15 & 16-17 for the Years 1985, 1990, 1995 & 2000 have been added. Data relating to area, population, density have been taken either from the published data by the Registrar General's Office or have been made available by them for use by the Ministry. Projected population statewise upto the Year 2001 based on 1991 census has also been added. Even Age-group wise population for selected major states based on 1991 census has been given.

2. Literacy

Tables 2.1 to 2.7 give data which have been compiled on the basis of published "Census of India 1961, 1971, 1981 & 1991-Social and Cultural Tables". Literacy rates for total population, in respect of 1961, 1971, 1981 and 1991 have been given, Sex-wise as well as state wise. Age-wise Literacy rates, however, have been provided on the basis of 1981 census. Literacy rates separately for rural/ urban areas have also been given in these tables.

3. Institutions and Enrolment

Tables 3.1 to 3.5 give the number of institutions by type and enrolment by stages. All India time series data for the period 1950-51 to 1994-95 as well as Statewise data for the period 1980-81 and 1990-91 have been given. Even class-wise, State-wise enrolment has been provided for 1980-81 and 1990-91.

4. Selected Indicators in Education

Tables 4.1 to 4.9 throw light on the development in the field of Education and measures the impact of Education system in India with the help of useful indices. These indicators are:

1. Index of Enrolment growth
2. Gross Enrolment Ratio
3. Teacher - Pupil Ratio
4. Drop-outs Rates
5. Efficiency of Education in India
6. Students flow in school classes (I to VIII)
7. Attrition Rates of Teachers

5. Expenditure on Education

Tables 5.1 to 5.7 give expenditure on education for different types of institutions. Breakup of the total expenditure by source has also been given. Direct expenditure on education has been given for All India and Statewise. Budgeted expenditure on education, Statewise and Sectorwise, have been given for the Year 1991-92 to 1993-94. This has been done with a view to present the growth during the seventh plan period. Percentage of budgeted expenditure on education to total budget have been given for all the States/UTs during the period 1989-90 to 1993-94.

6. School Teachers

Tables 6.1 to 6.5 give number of teachers by type of school i.e. Primary, Middle and High/Higher Secondary Schools, trained teachers and percentage of trained teachers to total number of teachers. Time series data for All India for different types of schools have also been given.

7. Plan Statistics on Education

Tables 7.1 to 7.4 giving plan statistics i.e. Outlay and expenditure data on education for I,II,III,IV,V VI and VII Plans. Sectorwise outlay and expenditure and the percentage of plan expenditure to total expenditure have been given in these tables.

8. School Buildings and Play Ground

Tables 8.1 to 8.4 give information regarding the availability of school buildings in the country for Primay, Middle, Secondary and Higher Secondary Schools. Distribution of schools according to type of accommodation as classified into Pacca, Semi

pacca, Kachha, Thatched huts, tents, open space and the shortage of rooms at various stages are given. Number of schools having play ground facilities has also been given.

9. Examination Results

In this addition, a new chapter on Results of examinations held for matriculation, Higher Secondary including intermediate/Old Pattern and selected Professional/Vocational/Technical courses of post matric diploma level have also been added for years 1987-88, 1988-89, 1989-90, 1990-91 & 1991-92.

CONTENTS

	Page
Preface-----	
Introduction-----	
CHAPTER-I	
DEMOGRAPHIC DATA	
Table 1.1 Growth of population- All India 1901-1991	1
Table 1.2 Estimated population in Age group 6-11,11-13,14-15 & 16-17 years - All India: 1981-2000	2
Table 1.3 Total Population-States and Union Territories 1981 and 1991.	3
Table 1.4 Projected Total Population-state wise-1990-91 to 2001.	4-5
Table 1.5 State wise Population as per 1981 Census-1985 to 2000 Age groups 6-10, 11 to 13, 14 to 15, and 16-17 years.	
(a) Age-group 6 to 10 years-	6
(b) Age group 11 to 13 years	7
(c) Age group 14 to 15 years	8
(d) Age group 16 to 17 years	9
Table 1.6 State wise Population in the age group 6-10, 11-13, and 14- 18 years from 1992 to 1996 (Base 1991 Census) for major states and India only.	
(a) Age group 6-10 years	10
(b) Age group 11-13 years	11
(c) Age group 14-18 years	12
Table 1.7 Educational level in India-1981	13
Table 1.8 Density, Sex Ratio and Literacy Rate All India-1901-1991.	14
Table 1.9 Area and variation in density states and union Territories- 1981-1991.	15
Table 1.10 Sex Ratio in States and Union Territories 1981 and 1991.	16
Table 1.11 Age distribution of Population in India 1981	17
Table 1.12 Population of Scheduled Castes and Scheduled Tribes as per census 1991	18

Chapter-II

2. LITERACY

Table 2.1 Literacy Rates - States and Union Territories 1971, 1981, and 1991	19-20
Table 2.2 Effective Literacy Rates (Excluding 0-4 age group) - 1961, 1971, 1981 & 1991	21
Table 2.3 Literacy Position of different age-groups in 1971 and 1981-INDIA	22
Table 2.4 Literacy position of the population in age group 15-35 by sex and Urban/Rural areas in 1971 and 1981-INDIA	23
Table 2.5 State-wise Literacy position of the adult population aged 15 and over in 1971 and 1981.	24
Table 2.6 Statewise Literacy Position in the age group 15-35 in 1981.	25
Table 2.7 Statewise Literacy Position in the age group 15-35 in Rural and Urban Area in 1981.	26-27

Chapter-III

3 INSTITUTIONS AND ENROLMENT

Table 3.1 Growth of Recognised Educational Institutions in India during 1950-51 to 1994-95.	28
Table 3.2 State-wise Number of Educational Institutions in India 1970-71, 1980-81, and 1990-91	29
Table 3.3 State-wise Growth of School Enrolment in India during 1950-51 to 1994-95.	30
Table 3.4(a) Enrolment by stages and sex (school level) for General Education in States and Union Territories-1980-81.	31
Table 3.4(b) Enrolment by stages and sex (school level) for General Education in States/UTs-1990-91.	32
Table 3.5 Enrolment by classes and sex in States and Union Territories-1980-81 and 1990-91	33-42

CHAPTER IV

4. SELECTED INDICATORS IN EDUCATION

Table 4.1	Index of Enrolment Growth by stages in India from 1960-61 to 1994-95 (school level)-Base year 1960-61.	43
Table 4.2	All India Gross Enrolment Ratio, at different level (School Education)- 1950-51 to 1993-94.	44
Table 4.3(a)	Gross Enrolment Ratios at different levels States/UTs 1980-81	45
	(b) Gross Enrolment Ratios at different levels - States/UTs-1990-91.	46
Table 4.4	Teacher Pupil Ratio (Av. No. of Students per teacher) in schools for General Education-States/UTs- 1980-81 & 1990-91.	47
Table 4.5	All India Drop-out Rates of Students of Schools for General Education for 1980-81 to 1994-95.	48
Table 4.6	State-wise Drop-out Rates of students of schools for General Education - 1990-91.	49
Table 4.7	Efficiency in Education	50-57
Table 4.8	Students flow in school classes (I to VIII) and Retention Rates during 1960-61 to 1990-91.	58-59
Table 4.9	State wise Attrition Rates of Teacher -1986	60-63

CHAPTER V

5 EXPENDITURE ON EDUCATION

Table 5.1	Total Expenditure on Education by Sources All India 1950-51 to 1989-90.	64
Table 5.2	Total Direct Expenditure by type of Institutions All India - 1950-51 to 1989-90.	65
Table 5.3	Total Direct Expenditure by type of Institution for General Education- States/Union Territories 1980-81 to 1989-90.	66
Table 5.4	Percentage of Educational Expenditure on Education Department to total Budget (Revenue Account) 1967-68 to 1993-94.	67

Table 5.5	State-wise Total & Budgeted Expenditure on Education and Training and other departments (Revenue Account)- 1991-92 to 1993-94.	68
Table 5.6	State-wise Total & Budgeted Expenditure on Education in selected subjects States/UTs- 1991-92 to 1993-94.	69-70
Table 5.7	Percentage of Budgeted Expenditure on Education of Education departments to total Budget (Revenue Account) States/UTs during 1989-90 to 1993-94.	71

CHAPTER VI

6 SCHOOL TEACHERS

Table 6.1	Growth of School Teacher in India-1950-51 to 1994-95	72
Table 6.2	Number of Teachers (Trained and Total) in Primary Schools in States/UTs- 1980-81 to 1990-91.	73
Table 6.3	Number of Teachers (Trained & Total) in Middle Schools in States/UTs-1980-81 to 1990-91.	74
Table 6.4	Number of Teachers (Trained & Total) in High/Higher Secondary Schools in States/UTs- 1980-81 to 1990-91.	75
Table 6.5	Percentage of Trained teachers to total number of teachers by type of Institutions-1980-81 to 1990-91.	76

CHAPTER VII

7 PLAN STATISTICS ON EDUCATION

Total 7.1	Plan Outlay and Expenditure on Education during various plans.	77
Table 7.2	Progress of Expenditure on Education during Eighth Five Year Plan- 1992-97.	78
Table 7.3	Expenditure on Education of Centre & States-Sector wise	79
Table 7.4	Percentage Expenditure on Each sub sector of Education to total Expenditure on Education of All Sectors/UTs and Centre.	80

CHAPTER VIII

8 SCHOOL BUILDINGS AND PLAY GROUNDS

Table 8.1	Schools having scope for additional construction- All India-1986.	81
Table 8.2	Distribution of Schools according to type of Accommodation All India - 1986.	82
Table 8.3 (a)	Additional classrooms required in primary schools in Rural and Urban Areas All India-1986.	83
	(b) Additional classrooms required in Middle/Secondary/ Higher Secondary Schools in Rural and Urban Areas- All India-1986.	84
Table 8.4	Number of Schools with Playground facilities-State wise - 1986.	85

CHAPTER IX

9 EXAMINATION RESULTS

(SCHOOL EDUCATION)

YEAR-1987-88

Table 9.1	Matriculation/School Leaving Certificate etc year 1987-88	86
Table 9.2	Higher Secondary (New Pattern 10+2), Old pattern & Intermediate/Pre degree/pre university-year 1987-88	87
Table 9.3	Post-Matric diploma/Certificate (Non leading to degree) Non-affiliated Commerce/Business management- Year 1987-88.	88
Table 9.4	Post-Matric diploma/Certificate (Not leading to degree) Non-affiliated Engineering/Technology/Architecture-Year 1987-88.	89
Table 9.5	Post-Matric diploma/Certificate (Not leading to degree) Non-affiliated Medicine/Nursing/Pharmacy/Dentistry- Year 1987-88.	90
Table 9.6	Post matric diploma/Certificate (Not leading to degree) Non affiliated others (including Education, Music and fine Arts & oriental students etc.) - Year 1987-88.	91

YEAR 1988-89

Table 9.7	Matriculation/School leaving Certificate etc-Year 1988-89.	92
Table 9.8	Higher Secondary (New Pattern 10+2), Old pattern, Intermediate/Pre degree/Pre university) year 1988-89.	93
Table 9.9	Post-Matric diploma/Certificate (not leading to degree) Commerce/Business Management -Year 1988-89.	94
Table9.10	Post-Matric Diploma/Certificate(Not leading to degree) non affiliated Engineering/Tech/Arch-year 1988-89.	95
Table9.11	Post-Matric diploma/Certificate (Not leading to degree) Non affiliated Medicine/Nursing/Pharmacy/Dentistry-year 1988-89.	96
Table9.12	Post-Matric diploma/Certificate (Not leading to degree) Non-affiliated others (including Education, Music, Fine Arts, Oriental Studies etc)-Year 1988-89.	97

YEAR-1989-90

Table9.13	Matriculation/School Leaving Certificate etc.Year 1989-90	98
Table9.14	Higher Secondary (New Pattern 10+2, old pattern, Intermediate/Pre degree/ Pre University)-Year 1989-90.	99
Table9.15	Post-Matric diploma/Certificate (not leading to degree)- Non affiliated Commerce/Business Management Year 1989-90.	100
Table9.16	Post-Matric diploma/Certificate (not leading to degree) Non-affiliated Engineering/Technology/Architecture-1989-90.	101
Table9.17	Post matric diploma/Certificate (Not leading to degree) Non-affiliated Medicine/Nursing/Pharmacy/Dentistry-Year 1989-90.	102
Table9.18	Post-Matric diploma/Certificate (Not leading to degree) Non affiliated others (including Education, Music & Fine Arts, Oriental Studies etc) Year 1989-90.	103

Year-1990-91

Table9.19	Matriculation/School Leaving Certificate etc Year 1990-91.	104
Table9.20	Higher Secondary (New Pattern 10+2, Old Pattern, Intermediate/Pre degree/Pre University-Year 1990-91.	105
Table9.21	Post-Matric diploma/Certificate (not leading to degree) Non-affiliated Commerce/Business Management-Year 1990-91.	106
Table9.22	Post-Matric diploma/Certificate (not leading to degree) Non affiliated Engineering/Technology/Architecture Year 1990-91.	107
Table9.23	Post-Matric diploma/Certificate (not leading to degree) Non-affiliated medicine/Nursing/Dentistry Year 1990-91.	108
Table9.24	Post-Matric diploma/Certificate (not leading to degree) Non-affiliated others (including Education, Music & Fine Arts Oriental Studies etc) Year 1990-91.	109

YEAR 1991-92

Table9.25	Matriculation/School Leaving Certificate - Year 1991-92.	110
Table9.26	Higher Secondary (New Pattern 10+2) Old pattern & Intermediate/Pre-degree/Pre University-Year 1991-92.	111
Table9.27	Post matric diploma/Certificate (not leading to degree) Non-affiliated Commerce/Business Management-Year 1991-92.	112
Table9.28	Post matric diploma/Certificate (not leading to degree) Non-affiliated Engineering/Technology/Architecture-Year 1991-92.	113
Table9.29	Post matric diploma/Certificate (not leading to degree) Non-affiliated medicine/Nursing/Pharmacy/Dentistry-Year 1991-92.	114
Table9.30	Post-Matric diploma/Certificate (not leading to degree) non-affiliated others (including Education, Music & Fine Arts Oriented Studies etc)-Year 1991-92.	115

CHAPTER -I

DEMOGRAPHIC DATA

TABLE NOs 1.1 TO 1.12

TABLE NO. 1.1

Growth of Population - All India 1901-1991

Year	Urban Population	Total Population	% Decadal variations in population	% of Urban Population
1	2	3	4	5
1901	25851873	238396327	-	10.84
1911	25941633	252093390	+5.75	10.29
1921	28086170	251321213	-0.31	11.18
1931	33455989	278977238	+11.00	11.99
1941	44153297	318660580	+14.22	13.86
1951	62443709	361088090	+13.31	17.29
1961	78936603	439234771	+21.64	17.97
1971	109113977	548159652	+24.80	19.91
1981	159462547	683329097	+25.00	23.34
1991	217611012	846302688	+24.00	25.71

Source : Final Population Totals, Census of India - 1991
Series - 1. Paper- 2 of 1992

GROWTH OF POPULATION ALL INDIA 1901-1991

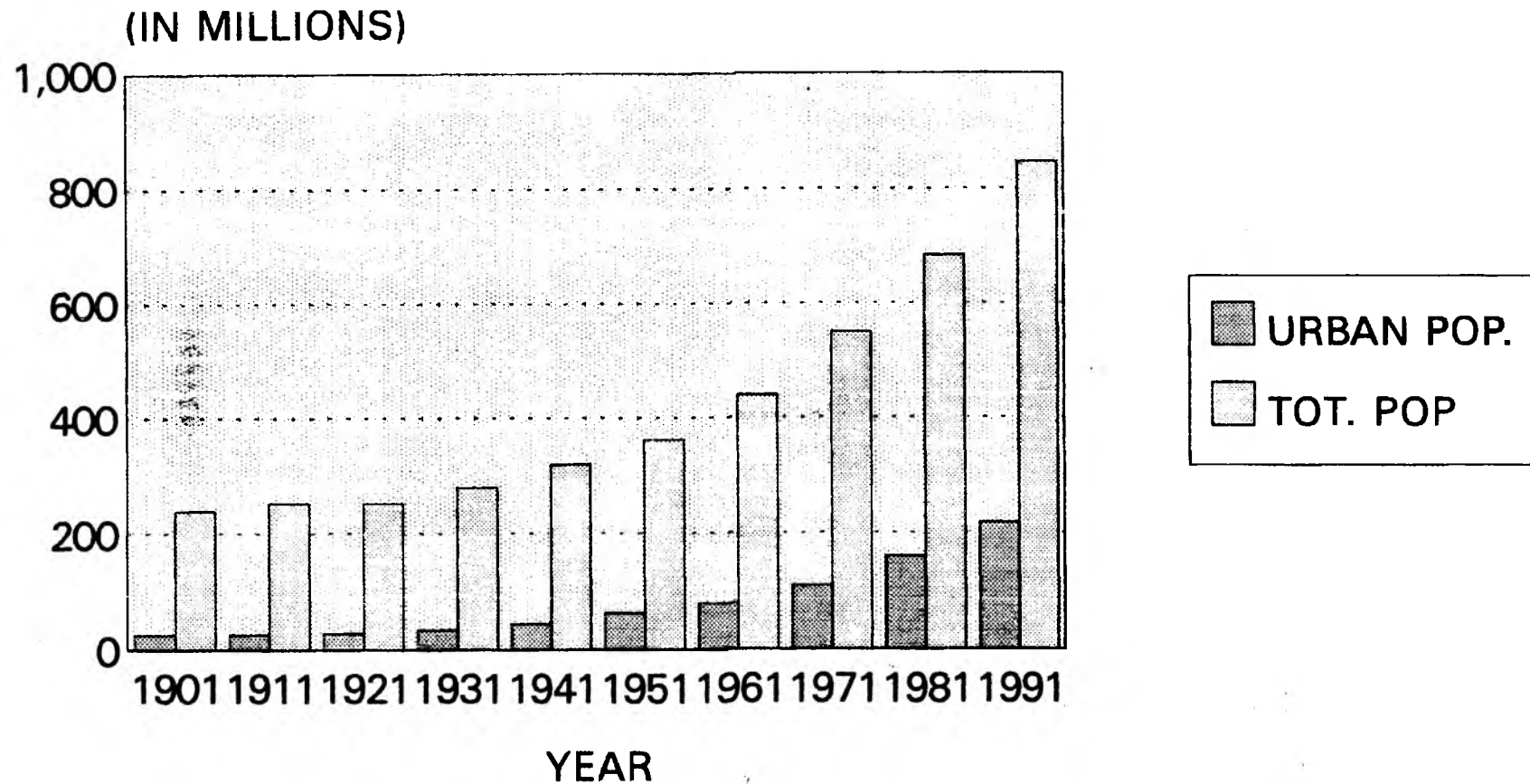

SOURCE : CENSUS OF INDIA SERIES (RGI)

TABLE NO. 1.2

Estimated Population in Age-Group 6-10, 11-13, 14-15, 16-17 - All India : 1981-2000

(Figure in thousands)

Year	6 - 10 Years			11 - 13 Years			14 - 15 Years			16 - 17		
	Male	Female	Total	Male	Female	Total	Male	Female	Total	Male	Female	Total
1	2	3	4	5	6	7	8	9	10	11	12	13
1981	45030	42477	87507	25490	24135	49625	16280	13962	30242	14095	12801	26846
1985	46922	44483	91405	27876	26121	53997	17764	16383	34147	16937	15409	32346
1990	49998	47355	96633	27900	26514	54624	18542	17516	36058	18551	17414	35965
1991	50375	47139	97514	28404	27127	55531	18708	17688	36396	18553	17459	36012
1992	50767	47639	98406	28917	27535	56452	18875	17860	36735	18555	17505	36060
1993	51162	48146	99308	29439	27949	57388	19042	18033	37075	18556	17550	36106
1994	51561	48660	10021	29970	28369	58339	19208	18205	37413	18558	17595	36153
1995	51964	49181	101145	30430	28776	59226	19375	18377	37752	18560	17641	36201
1996	52092	49302	101394	30623	28773	59396	19612	18593	38205	18917	17947	36864
1997	52220	49424	101644	30735	28751	59486	19850	18808	38658	19274	18254	37528
1998	52349	49546	101895	30847	28732	59579	20087	19023	39110	19632	18561	38193
1999	52478	49668	102146	30960	28714	59674	20325	19238	39563	19989	18868	38857
2000	52518	49791	102398	31153	29503	60656	20562	19454	40016	20346	19175	39521

Source : Office of the Registrar General of India Expert Committee on population projection - 1981

Note : Figures relate to as on 1st March.

TABLE NO. 1.3

Total Population - States and Union Territories - 1981 and 1991

S.no.	State/UTs	1981			1991		
		Persons	Male	Female	Persons	Male	Female
1	2	3	4	5	6	7	8
1	ANDHRA PRADESH	53649673	27108922	26440751	66508008	33724581	32783427
2	ARUNACHAL PRADESH	631839	339322	292517	864558	465004	399554
3	ASSAM	18041248++	9444037++	8597211++	22414322	11657989	10756333
4	BIHAR	69914734	35930560	33984174	86374465	45202091	41172374
5	GOA	1007749	510152	497597	1169793	594790	575003
6	GUJARAT	34085799	17552640	16533159	41309582	21355209	19954373
7	HARYANA	12922618	6909938	6012680	16463648	8827474	7636174
8	HIMACHAL PRADESH	4280818	2169931	2110887	5170877	2617467	2553410
9	JAMMU & KASHMIR	5987389	3164660	2822729	7718700+	4014100+	3704600+
10	KARNATAKA	37135714	18922627	18213087	44977201	22951917	22025284
11	KERALA	25453680	12527767	12925913	29098518	14288995	14809523
12	MADHYA PRADESH	52178844	26886305	25292539	66181170	34267293	31913877
13	MAHARASHTRA	62784171	32415126	30369045	78937187	40825618	38111569
14	MANIPUR	1420953	721006	699947	1837149	938359	898790
15	MEGHALAYA	1335819	683710	652109	1774778	907687	867091
16	MIZORAM	493757	257239	236518	689756	358978	330778
17	NAGALAND	774930	415910	359020	1209546	641282	568264
18	ORISSA	26307271	13309786	13060485	31659736	16064146	15595590
19	PUNJAB	16788915	8937210	7851705	20281969	10778034	9503935
20	RAJASTHAN	34261862	17854154	16407708	44005990	23042780	20963210
21	SIKKIM	316385	172440	143945	406457	216427	190030
22	TAMIL NADU	48408077	24487624	23920453	55858946	28298975	27559971
23	TRIPURA	2053058	1054846	998212	2757205	1417930	1339275
24	UTTAR PRADESH	110862013	58819276	52042737	139112287	74036957	65075330
25	WEST BENGAL	54580647	28560901	26019746	68077965	35510633	32567332
26	A & N ISLANDS	188741	107261	81480	280661	154369	126292
27	CHANDIGARH	451610	255278	196332	642015	358614	283401
28	DADRA & NAGAR HAVELI	103676	52515	51161	138477	70953	67524
29	DAMAN & DIU	78981	38298	40683	101586	51595	49991
30	DELHI	56220406	3440081	278032	9420644	5155512	4265132
31	LAKSHADWEEP	40249	20377	19872	51707	26618	25089
32	PONDICHERRY	604471	304561	299910	807785	408081	399704
INDIA		683329097	353374460	329954637	846302688	439230458	407072230

+ Census could not be held in J&K in 1991, therefore it is projected population.

(as projected by the Standing Committee of experts)

++ Census could not be held in Assam in 1981, it is projected population.

Note: Figures relate to as on 1st March.

Source: Office of the Registrar General of India

Table - 1.4

Projected Total Population - Statewise 1991 to 2001 as on 1st March
(As released by the Standing Committee of Registrar General of India)

(Figures in hundreds)

Sno.	State/UTs.	1991	1992	1993	1994	1995	1996
1	2	3	4	5	6	7	8
1	ANDHRA PRADESH	665080	677296	689404	701387	713239	724961
2	ARUNACHAL PRADESH	8646	8860	9080	9304	9535	9771
3	ASSAM	224143	229157	234236	239362	244446	249451
4	BIHAR	863745	883237	902955	922789	942568	962197
5	GOA	11698	11929	12165	12404	12648	12899
6	GUJARAT	413096	420796	428417	435998	443601	451274
7	HARYANA	164636	168411	172155	175861	179526	183146
8	HIMACHAL PRADESH	51709	52693	53695	54716	55757	56819
9	JAMMU & KASHMIR	77187	78934	80721	82549	84418	86329
10	KARNATAKA	449772	457142	464336	471367	478295	485076
11	KERALA	290985	295173	299347	303517	307684	311857
12	MADHYA PRADESH	661812	675684	689518	703275	716919	730424
13	MAHARASHTRA	789372	804971	820947	837221	853615	870019
14	MANIPUR	18371	18801	19241	19691	20152	20624
15	MEGHALAYA	17748	18159	18580	19011	19451	19902
16	MIZORAM	6898	7115	7339	7571	78107	8056
17	NAGALAND	12095	12481	12881	13292	13717	14156
18	ORISSA	316597	322563	328573	334612	340693	346679
19	PUNJAB	202820	205998	209098	212140	214897	218195
20	RAJASTHAN	440060	449821	459593	469323	478925	488350
21	SIKKIM	4065	4197	4333	4475	4621	4771
22	TAMIL NADU	558589	564384	570035	575579	581062	586513
23	TRIPURA	27572	28211	28865	29535	30219	30920
24	UTTAR PRADESH	1391123	1416621	1442128	1467575	1492871	1517931
25	WEST BENGAL	680780	692617	704683	716841	728838	740507
26	A & N ISLANDS	2807	2908	3015	3125	3239	3357
27	CHANDIGARH	6420	6715	7021	7337	7664	8000
28	DADRA & NAGAR HAVEL	1385	1423	1462	1502	1543	1584
29	DAMAN & DIU	1016	1039	1059	1080	1101	1123
30	DELHI	94206	97565	101045	104648	108379	112244
31	LAKSHADWEEP	517	530	543	556	570	584
32	PONDICHERRY	8078	8243	8412	8584	8759	8939
INDIA		8463027	8624806	8785918	8946440	9106662	9266735

Contd...

Table - 1.4

Projected Total Population - Statewise 1991 to 2001 as on 1st March
(As released by the Standing Committee of Registrar General of India)

(Figures in hundreds)

Sno.	State/UTs.	1997	1998	1999	2000	2001
1	2	9	10	11	12	13
1	ANDHRA PRADESH	736558	748050	759463	770836	782221
2	ARUNACHAL PRADESH	10019	10274	10534	10801	11075
3	ASSAM	254384	259251	264061	268229	273585
4	BIHAR	981740	1001274	1020884	1040697	1060881
5	GOA	13163	13432	13707	13987	14273
6	GUJARAT	459022	466859	474801	482867	491069
7	HARYANA	186723	190259	193762	197238	200700
8	HIMACHAL PRADESH	57951	59105	60282	61484	62709
9	JAMMU & KASHMIR	87994	89692	91425	93192	94994
10	KARNATAKA	491770	498359	504848	511192	517568
11	KERALA	316036	320225	324423	328630	332843
12	MADHYA PRADESH	743802	757069	770253	783394	796546
13	MAHARASHTRA	886490	903071	919784	936665	953768
14	MANIPUR	21123	21635	22158	22694	23243
15	MEGHALAYA	20378	20867	21367	21878	22403
16	MIZORAM	8313	8579	8852	9135	9425
17	NAGALAND	14617	15092	15584	16091	16615
18	ORISSA	352695	358705	364717	370737	376785
19	PUNJAB	221238	224301	227395	230526	233706
20	RAJASTHAN	497619	506755	515786	524755	533721
21	SIKKIM	4927	5089	5256	5428	5605
22	TAMIL NADU	591954	597404	602875	608378	613917
23	TRIPURA	31663	32424	33204	34002	34819
24	UTTAR PRADESH	1542826	1567594	1592291	1616993	1641804
25	WEST BENGAL	751898	763042	773947	784646	795191
26	A & N ISLANDS	3479	3606	3738	3875	4016
27	CHANDIGARH	8326	8660	9004	9357	9717
28	DADRA & NAGAR HAVEL	1626	1670	1715	1761	1807
29	DAMAN & DIU	1145	1169	1193	1218	1243
30	DELHI	116223	120344	124610	129027	133601
31	LAKSHADWEEP	598	613	628	643	659
32	PONDICHERRY	9128	9319	9515	9714	9919
	INDIA	9426578	9586136	9745430	9914491	10063375

Note : These estimates are Provisional

TABLE 1.5 (a)
Statewise Population as per 1981 census (a) Age - Group - 6 to 10 years - 1985 to 2000

(Figures in thousands)

S.no.	State/UTs	1985			1990			1995			2000		
		Persons	Male	Female	Persons	Male	Female	Persons	Male	Female	Persons	Male	Female
1	2	3	4	5	6	7	8	9	10	11	12	13	14
1	ANDHRA PRADESH	6721	3384	3337	6950	3512	3438	7335	3723	3612	7347	3732	3615
2	ASSAM	3061	1587	1474	3141	1615	1526	3321	1702	1619	3530	1811	1719
3	BIHAR	9801	4947	4854	10265	5205	5060	11360	5788	5572	12292	6238	6054
4	GUJARAT	4432	2269	2163	4636	2363	2273	4587	2339	2248	4292	2190	2102
5	HARYANA	1785	939	846	2000	994	1006	2103	1100	1003	1883	984	899
6	HIMACHAL PRADESH	574	292	282	588	295	293	593	296	297	592	294	298
7	JAMMU & KASHMIR	826	427	399	857	440	417	911	465	446	967	491	476
8	KARNATAKA	4962	2498	2464	5241	2676	2565	5357	2749	2608	5139	2634	2505
9	KERALA	2944	1491	1453	3073	1564	1509	3111	1581	1530	3023	1534	1489
10	MADHYA PRADESH	7099	3628	3471	7603	3935	3668	8077	4186	3891	8150	4213	3937
11	MAHARASHTRA	7923	4052	3871	8206	4221	3985	7869	3965	3904	7147	3695	3452
12	MANIPUR	188	95	93	232	118	114	251	132	119	237	124	113
13	MEGHALAYA	199	99	100	227	113	114	236	118	118	235	118	117
14	NAGALAND	110	56	54	132	67	65	158	80	78	187	95	92
15	ORISSA	3496	1748	1748	3504	1790	1714	3640	1877	1763	3704	1911	1793
16	PUNJAB	2068	1098	970	2189	1144	1045	1982	1026	956	1784	919	865
17	RAJASTHAN	4980	2573	2407	5646	2906	2740	6363	3265	3098	6899	3536	3363
18	SIKKIM	47	24	23	57	29	28	68	34	34	78	39	39
19	TAMIL NADU	5493	2795	2698	5787	2959	2828	5831	2986	2845	5601	2869	2732
20	TRIPURA	264	134	130	286	146	140	314	158	156	337	167	170
21	UTTAR PRADESH	15757	8371	7386	16815	8863	7952	18376	9631	8745	19986	10413	9573
22	WEST BENGAL	6919	3458	3461	7331	3716	3615	7681	3930	3751	7499	3843	3656
23	A & N ISLANDS	31	16	15	41	20	21	52	25	27	63	29	34
24	ARUNACHAL PRADESH	91	46	45	105	53	52	116	57	59	123	60	63
25	CHANDIGARH	60	32	28	78	41	37	99	52	47	124	65	59
26	DADRA & NAGAR HAVELI	16	8	8	17	9	8	17	9	8	15	9	6
27	DELHI	827	444	383	984	529	455	1170	630	540	1387	747	640
28	GOA, DAMAN & DIU	124	63	61	132	66	66	138	68	68	129	65	64
29	LAKSHADWEEP	6	3	3	6	3	3	6	3	3	6	3	3
30	MIZORAM	69	35	34	78	40	38	89	46	43	99	51	48
31	PONDICHERY	74	37	37	75	38	37	75	38	37	75	38	37
INDIA		91405	46922	44483	96633	49988	47355	101145	51964	49181	102930	52917	50013

Source : Revised Population Estimates for the age groups year based on 1981 - census - as reported by an Expert committee set up by the Planning Commission.

TABLE 1.5 (b)
Statewise Population as per 1981 census (b) Age - Group - 11 to 13 years - 1985 to 2000

(Figures in thousands)

S.no.	State/UTs	1985			1990			1995			2000		
		Persons	Male	Female	Persons	Male	Female	Persons	Male	Female	Persons	Male	Female
1	2	3	4	5	6	7	8	9	10	11	12	13	14
1	ANDHRA PRADESH	4410	2212	2198	3880	1954	1926	4224	2138	2086	4395	2228	2167
2	ASSAM	1703	883	820	1845	955	890	1871	959	912	2005	1028	977
3	BIHAR	6092	3136	2956	5702	2849	2853	6235	3167	3068	6861	3481	3380
4	GUJARAT	2620	1356	1264	2638	1344	1294	2797	1425	1372	2717	1384	1333
5	HARYANA	1061	565	496	1066	558	508	1306	685	621	1235	647	588
6	HIMACHAL PRADESH	331	168	163	341	173	168	349	174	175	349	173	176
7	JAMMU & KASHMIR	493	254	239	486	251	235	514	264	250	544	278	266
8	KARNATAKA	2948	1481	1467	2948	1485	1463	3177	1628	1549	3193	1638	1555
9	KERALA	1795	902	893	1747	884	863	1861	947	914	1855	942	913
10	MADHYA PRADESH	4306	2177	2129	4172	2138	2034	4637	2404	2233	4829	2501	2328
11	MAHARASHTRA	4869	2515	2354	4745	2422	2323	5058	2612	2446	4506	2332	2174
12	MANIPUR	111	57	54	111	56	55	146	74	72	149	79	70
13	MEGHALAYA	108	54	54	122	60	62	140	69	71	141	70	71
14	NAGALAND	65	33	32	78	40	38	94	48	46	112	57	55
15	ORISSA	2147	1073	1074	2043	1023	1020	2158	1079	1079	2187	1128	1059
16	PUNJAB	1233	653	580	1234	655	579	1323	688	635	1147	593	554
17	RAJASTHAN	2875	1487	1388	2975	1536	1439	3476	1787	1689	3863	1981	1882
18	SIKKIM	27	14	13	31	16	15	37	19	18	43	22	21
19	TAMIL NADU	3367	1706	1661	3245	1651	1594	3514	1798	1716	3463	1773	1690
20	TRIPURA	169	86	83	155	79	76	176	91	85	189	95	94
21	UTTAR PRADESH	9235	4929	4306	9282	4914	4368	10117	5316	4801	11297	5767	5530
22	WEST BENGAL	4307	2198	2109	4062	2024	2038	4466	2276	2190	4601	2356	2245
23	A & N ISLANDS	16	8	8	21	11	10	26	13	13	31	15	16
24	ARUNACHAL PRADESH	50	26	24	57	29	28	64	32	32	70	35	35
25	CHANDIGARH	35	19	16	44	24	20	56	30	26	71	38	33
26	DADRA & NAGAR HAVELI	8	4	4	10	5	5	10	5	5	10	5	5
27	DELHI	481	262	219	578	315	263	691	377	314	820	447	373
28	GOA, DAMAN & DIU	81	42	39	75	38	37	83	41	42	84	42	42
29	LAKSHADWEEP	4	2	2	4	2	2	4	2	2	4	2	2
30	NIZORAM	41	21	20	47	24	23	55	28	27	63	32	31
31	PONDICHERY	46	23	23	45	23	22	46	23	23	45	23	22
	INDIA	53997	27876	26121	54624	27900	26514	59226	30430	28776	59772	31153	29503

Source : Revised Population Estimates for the age groups year based on 1981 - census - as reported by an Expert committee set up by the Planning Commission.

TABLE 1.5 (c)
Statewise Population as per 1981 census (c) Age - Group - 14 to 15 years - 1985 to 2000
(Figures in thousands)

S.no.	State/UTs	1985			1990			1995			2000		
		Persons	Male	Female	Persons	Male	Female	Persons	Male	Female	Persons	Male	Female
1	2	3	4	5	6	7	8	9	10	11	12	13	14
1	ANDHRA PRADESH	2703	1366	1337	2768	1388	1380	2671	1347	1324	2882	1458	1424
2	ASSAM	1033	529	504	1184	614	570	1234	636	598	1282	657	625
3	BIHAR	3676	1902	1774	3921	1982	1939	3919	1968	1951	4344	2204	2140
4	GUJARAT	1703	883	820	1746	896	850	1810	921	889	1843	939	904
5	HARYANA	687	369	318	704	372	332	793	416	377	860	452	408
6	HIMACHAL PRADESH	213	108	105	223	113	110	228	114	114	230	114	116
7	JAMMU & KASHMIR	312	162	150	327	169	158	330	170	160	349	179	170
8	KARNATAKA	1862	941	921	1962	984	978	2035	1034	1001	2131	1093	1038
9	KERALA	1190	593	597	1176	593	583	1200	609	591	1241	631	610
10	MADHYA PRADESH	2671	1371	1300	2817	1430	1387	2913	1503	1410	3164	1641	1523
11	MAHARASHTRA	3169	1621	1548	3218	1651	1567	3247	1664	1583	3214	1664	1550
12	MANIPUR	71	36	35	73	37	36	85	43	42	100	52	48
13	MEGHALAYA	68	34	34	77	38	39	88	43	45	95	47	48
14	NAGALAND	42	22	20	52	26	26	62	32	30	74	38	36
15	ORISSA	1338	671	667	1397	698	699	1368	694	674	1424	735	689
16	PUNJAB	802	424	378	821	436	385	864	450	414	826	428	398
17	RAJASTHAN	1807	951	856	1935	1000	935	2131	1098	1033	2442	1254	1188
18	SIKKIM	17	9	8	21	11	10	24	13	11	27	14	13
19	TAMIL NADU	2201	1113	1088	2191	1112	1079	2243	1145	1098	2330	1193	1137
20	TRIPURA	110	56	54	108	55	53	109	56	53	121	62	59
21	UTTAR PRADESH	5583	3001	2582	6031	3257	2774	6369	3356	3013	6963	3648	3315
22	WEST BENGAL	2775	-1420	1355	2772	1399	1373	2820	1422	1398	3030	1550	1480
23	A & N ISLANDS	10	5	5	13	7	6	16	8	8	18	9	9
24	ARUNACHAL PRADESH	30	16	14	35	18	17	40	20	20	44	22	22
25	CHANDIGARH	23	13	10	29	16	13	38	21	17	47	26	21
26	DADRA & NAGAR HAVELI	6	3	3	6	3	3	7	4	3	7	4	3
27	DELHI	319	176	143	387	213	174	468	258	210	561	309	252
28	GOA, DAMAN & DIU	54	28	26	53	27	26	54	27	27	57	28	29
29	LAKSHADWEEP	2	1	1	2	1	1	2	1	1	2	1	1
30	MIZORAM	27	14	13	33	17	16	39	20	19	45	23	22
31	PONDICHERY	31	16	15	31	15	16	30	15	15	30	15	15
INDIA		34147	17764	16383	36058	18542	17516	37752	19375	18377	40016	20562	19454

Source : Revised Population Estimates for the age groups year based on 1981 - census - as reported by an Expert committee set up by the Planning Commission.

TABLE 1.5 (d)
Statewise Population as per 1981 census (d) Age - Group - 16 to 17 years - 1985 to 2000

(Figures in thousands)

S.no.	State/UTs	1985			1990			1995			2000		
		Persons	Male	Female	Persons	Male	Female	Persons	Male	Female	Persons	Male	Female
1	2	3	4	5	6	7	8	9	10	11	12	13	14
1	ANDHRA PRADESH	6721	3384	3337	6950	3512	3438	7335	3723	3612	7347	3732	3615
2	ASSAM	3061	1587	1474	3141	1615	1526	3321	1702	1619	3530	1811	1719
3	BIHAR	9801	4947	4854	10265	5205	5060	11360	5788	5572	12292	6238	6054
4	GUJARAT	4432	2269	2163	4636	2363	2273	4587	2339	2248	4292	2190	2102
5	HARYANA	1785	939	846	2000	994	1006	2103	1100	1003	1883	984	899
6	HIMACHAL PRADESH	574	292	282	588	295	293	593	296	297	592	294	298
7	JAMMU & KASHMIR	826	427	399	857	440	417	911	465	446	967	491	476
8	KARNATAKA	4962	2498	2464	5241	2676	2565	5357	2749	2608	5139	2637	2505
9	KERALA	2944	1491	1453	3073	1564	1509	3111	1581	1530	3023	1534	1489
10	MADHYA PRADESH	7099	3628	3471	7603	3935	3668	8077	4186	3891	8150	4213	3937
11	MAHARASHTRA	7923	4052	3871	8206	4221	3985	7869	3965	3904	7147	3695	3452
12	MANIPUR	188	95	93	232	118	114	251	132	119	237	124	113
13	MEGHALAYA	199	99	100	227	113	114	236	118	118	235	118	117
14	NAGALAND	110	56	54	132	67	65	158	80	78	187	95	92
15	ORISSA	3496	1748	1748	3504	1790	1714	3640	1877	1763	3704	1911	1793
16	PUNJAB	2068	1098	970	2189	1144	1045	1982	1026	956	1784	919	865
17	RAJASTHAN	4980	2573	2407	5646	2906	2740	6363	3265	3098	6899	3536	3363
18	SIKKIM	47	24	23	57	29	28	68	34	34	78	39	39
19	TAMIL NADU	5493	2795	2698	5787	2959	2828	5831	2966	2845	5601	2869	2732
20	TRIPURA	264	134	130	286	146	140	314	158	156	337	167	170
21	UTTAR PRADESH	15757	8371	7386	16815	8863	7952	18376	9631	8745	19986	10413	9573
22	WEST BENGAL	6919	3458	3461	7331	3716	3615	7681	3930	3751	7499	3843	3656
23	A & N ISLANDS	31	16	15	41	20	21	52	25	27	63	29	34
24	ARUNACHAL PRADESH	91	46	45	105	53	52	116	57	59	123	60	63
25	CHANDIGARH	60	32	28	78	41	37	99	52	47	124	65	59
26	DADRA & NAGAR HAVELI	16	8	8	17	9	8	17	9	8	15	9	6
27	DELHI	827	444	383	984	529	455	1170	630	540	1387	747	640
28	GOA, DAMAN & DIU	124	63	61	132	66	66	138	68	68	129	65	64
29	LAKSHADWEEP	6	3	3	6	3	3	6	3	3	6	3	3
30	MIZORAM	69	35	34	78	40	38	89	46	43	99	51	48
31	PONDICHEERY	74	37	37	75	38	37	75	38	37	75	38	37
	INDIA	91405	46922	44483	96633	49988	47355	101145	51964	49181	102398	52518	49791

Source : Revised Population Estimates for the age groups year based on 1981 - census - as reported by an Expert committee set up by the Planning Commission.

TABLE NO. 1.6

Statewise Population in the age group 6-10,11-13 and 14-18 years from 1992 to 1996(Base on 1991 census)
+
for major States and India Only
(a) Age group 6-10 years

(Figures in thousands)

S.no.	State/UTs	1992			1993			1994			1995			1996		
		Persons	Males	Female	Persons	Males	Female	Persons	Males	Female	Persons	Males	Female	Persons	Males	Female
1	2	3	4	5	6	7	8	9	10	11	12	13	14	15	16	17
1	ANDHRA PRADESH	7528	3842	3686	7683	3925	3758	7837	4007	3830	7990	4089	3901	8050	4120	3930
2	ASSAM	2718	1446	1372	2853	1463	1390	2886	1479	1407	2921	1496	1425	2965	1517	1448
3	BIHAR	11194	5834	5360	11452	5972	5480	11711	6111	5600	11970	6250	5720	12098	6311	5787
4	GUJARAT	4906	2533	2373	4963	2562	2401	5021	2592	2429	5078	2621	2457	5114	2655	2459
5	HARYANA	2078	1097	981	2127	1123	1004	2175	1148	1027	2222	1173	1049	2234	1179	1055
6	KARNATAKA	5051	2595	2456	5077	2611	2466	5102	2627	2475	5127	2642	2485	5107	2631	2476
7	KERALA	2958	1498	1460	2947	1488	1459	2949	1492	1457	2943	1488	1455	2935	1484	1451
8	MADHYA PRADESH	8309	4313	3996	8473	4399	4074	8617	4485	4132	8802	4572	4230	8845	4592	4253
9	MAHARASHTRA	8892	4586	4306	9031	4659	4372	9171	4733	4438	9311	4807	4504	9390	4847	4543
10	ORISSA	3870	1881	1989	3924	1916	2008	3979	1951	2028	4033	1986	2047	4063	2008	2055
11	PUNJAB	2261	1189	1072	2270	1192	1078	2230	1145	1085	2289	1197	1092	2273	1188	1085
12	RAJASTHAN	5757	2996	2761	5839	3037	2802	5921	3078	2843	6002	3119	2883	6027	3131	2896
13	TAMIL NADU	5695	2910	2785	5606	2875	2731	5535	2839	2696	5565	2804	2761	5379	2765	2614
14	UTTAR PRADESH	17440	9259	8181	17658	9364	8294	17877	9470	8407	18095	9575	8520	18251	9647	8504
15	WEST BENGAL	7837	3986	3851	7915	4033	3882	7993	4080	3913	8140	4197	3743	8066	4129	3937
	INDIA	100704	52000	48704	101855	52541	49314	103492	53567	49925	104764	54229	50535	105170	54430	50740

- + Registrar General of India has released estimate of population in the age groups only for major States.
* All India total includes estimates population of all States/UTs and not only major States indicated above.

Contd..

TABLE NO. 1.6

Statewise Population in the age group 6-10,11-13 and 14-18 years from 1992 to 1996(Based on 1991 census)

+
for major States and India Only
(b) Age group 11-13 years
(Figures in thousands)

S.no.	State/UTs	1992			1993			1994			1995			1996		
		Persons	Males	Female	Persons	Males	Female	Persons	Males	Female	Persons	Males	Female	Persons	Males	Female
1	2	18	19	20	21	22	23	24	25	26	27	28	29	30	31	32
1	ANDHRA PRADESH	4141	2107	2034	4408	2249	2159	4324	2207	2117	4230	2154	2076	4495	2294	2201
2	ASSAM	1651	851	800	1618	829	789	1629	836	793	1641	844	797	1649	845	804
3	BIHAR	5950	3068	2882	6605	3442	3163	6386	3317	3069	6168	3192	2976	6723	3502	3221
4	GUJARAT	2718	1402	1316	2938	1516	1422	2865	1478	1387	2791	1440	1351	2960	1527	1433
5	HARYANA	1126	596	530	1222	647	575	1190	630	560	1158	613	545	1249	661	588
6	KARNATAKA	2978	1516	1462	2979	1533	1446	2979	1527	1452	2979	1522	1457	3000	1544	1456
7	KERALA	1740	880	860	1801	912	889	1786	907	879	1761	891	870	1791	906	885
8	MADHYA PRADESH	4486	2316	2170	4919	2556	2363	4775	2476	2299	4630	2396	2234	4995	2595	2400
9	MAHARASHTRA	5007	2574	2433	5350	2790	2560	5212	2694	2518	5104	2629	2475	5378	2779	2599
10	ORISSA	2135	1047	1088	2243	1099	1144	2206	1081	1125	2171	1064	1107	2274	1120	1154
11	PUNJAB	1283	682	601	1367	717	650	1339	705	634	1312	694	618	1366	716	650
12	RAJASTHAN	3164	1651	1513	3431	1786	1645	3362	1741	1601	3253	1696	1557	3464	1802	1662
13	TAMIL NADU	3360	1717	1643	3538	1814	1724	3439	1782	1657	3417	1747	1670	3465	1777	1688
14	UTTAR PRADESH	9822	5233	4589	10155	5387	4768	10044	5336	4708	9933	5285	4648	10293	5460	4833
15	WEST BENGAL	4389	2208	2181	4746	2437	2309	4601	2335	2266	4496	2272	2224	4731	2413	2318
	INDIA	56744	29344	27400	59944	31042	28902	58877	30476	28401	57811	29910	27901	60604	31379	29225

- + Registrar General of India has released estimate of population in the age groups only for major States.
- * All India total includes estimates population of all States/UTs and not only major States indicated above.

Contd..

TABLE NO. 1.6

Statewise Population in the age group 6-10,11-13 and 14-18 years from 1992 to 1996(Base on 1991 census)

+
for major States and India Only
(c) Age group 14-18 years

(Figures in thousands)

S.no.	State/UTs	1992			1993			1994			1995			1996		
		Persons	Males	Female	Persons	Males	Female	Persons	Males	Female	Persons	Males	Female	Persons	Males	Female
1	2	33	34	35	36	37	38	39	40	41	42	43	44	45	46	47
1	ANDHRA PRADESH	7027	3557	3470	6928	3509	3419	6828	3461	3367	6729	3413	3316	6876	3491	3385
2	ASSAM	2646	1367	1279	2679	1385	1294	2710	1400	1310	2741	1415	1326	2739	1412	1327
3	BIHAR	9558	4955	4603	9540	4927	4613	9521	4899	4622	9502	4871	4631	9821	5049	4772
4	GUJARAT	4301	2233	2068	4332	2244	2088	4363	2255	2108	4394	2266	2128	4495	2318	2177
5	HARYANA	1774	947	827	1789	953	836	1805	959	846	1821	965	856	1873	993	880
6	KARNATAKA	4919	2486	2433	4925	2492	2433	4929	2497	2432	5000	2503	2497	4945	2516	2429
7	KERALA	2869	1443	1426	2868	1444	1424	2867	1446	1421	2866	1448	1418	2944	1458	1486
8	MADHYA PRADESH	7143	3649	3494	7165	3670	3495	7186	3691	3495	7208	3712	3496	7420	3829	3591
9	MAHARASHTRA	8258	4269	3979	8245	4267	3978	8272	4266	4006	8278	4264	4014	8432	4349	4083
10	ORISSA	3449	1722	1727	3457	1716	1741	3464	1710	1754	3473	1705	1768	3531	1735	1796
11	PUNJAB	2056	1100	956	2068	1105	963	2080	1111	969	2092	1116	976	2127	1131	996
12	RAJASTHAN	4912	2569	2343	4977	2601	2376	5042	2634	2408	5106	2666	2440	5230	2729	2501
13	TAMIL MADU	5516	2807	2709	5512	2808	2704	5509	2809	2700	5506	2811	2695	5550	2836	2714
14	UTTAR PRADESH	15746	8435	7311	15808	8454	7354	15869	8473	7396	15930	8491	7439	16111	8576	7535
15	WEST BENGAL	7172	3630	3542	7152	3610	3542	7133	3591	3542	7175	3633	3542	7259	3657	3602
	INDIA	90851	47108	43743	91416	47354	44062	91979	47599	44380	92544	47845	44699	93406	48707	44699

+ Registrar General of India has released estimate of population in the age groups only for major States.
* All India total includes estimates population of all States/UTs and not only major States indicated above.

TABLE NO. 1.7

Educational level in India - 1981

(Figures in Millions)

Educational Levels		All Areas		Urban	
1	2	Male	Females	Male	Total
		3	4	5	6
Population		3439.30 (100.00)	3213.60 (100.00)	838.76 (100.00)	738.04 (100.00)
Illiterates		1826.45 (53.10)	2416.11 (75.18)	286.57 (34.17)	385.08 (52.18)
Literates without Educational Level		496.44 (14.43)	277.63 (8.64)	120.75 (14.40)	95.87 (12.09)
Primary		467.70 (13.60)	260.77 (8.11)	131.75 (15.71)	100.95 (13.68)
Middle		288.60 (8.39)	133.41 (4.15)	103.53 (12.34)	66.80 (9.05)
Matriculation Secondary		203.86 (5.93)	75.10 (2.34)	99.30 (11.84)	49.69 (6.73)
Hr.Sec./Inter/Pre.Univ.		74.25 (2.16)	23.96 (0.75)	41.79 (4.98)	18.56 (2.51)
on-Tech. Diploma not equal degree		1.09 (0.03)	0.67 (0.02)	0.38 (0.45)	0.37 (0.05)
Tech. Diploma not equal to degree		10.53 (0.03)	2.74 (0.08)	5.78 (0.69)	1.51 (0.02)
Univ.degree or P.Graduate Degree		70.38 (2.05)	23.18 (0.72)	41.10 (4.90)	17.09 (2.32)

Note : Figures in bracket indicate the percentage

Source : Census of India - 1981, Series-I, Part-IIA- Social & Cultural Tables

TABLE NO. 1.8

Density, Sex Ratio and Literacy Rate All India- 1901-1991

Year	Population Sq. Km.	Female per thousand Males		Literacy Rate (%)		
		Total	Urban	Male	Female	Total
1	2	3	4	5	6	7
1901	77	972	910	9.80	0.60	5.30
1911	82	964	872	10.60	1.10	5.90
1921	81	955	846	12.20	1.80	7.20
1931	90	950	838	15.60	2.90	9.50
1941	103	945	831	24.90	7.30	16.10
1951	117	946	860	24.90	7.90	16.70
1961	142	941	845	34.40	13.00	24.00
1971	177	930	858	39.50	18.70	29.40
1981	216	935	880	56.50	29.85	43.63
1991	267	927	894	64.13	39.29	52.21

@ Source: Census of India 1981: Series 1 Part IIB(i)

(i) Primary Census Abstract General Population Tables.

TABLE NO. 1.9
Area and Variation in density States and Union Territories 1981-1991

Sno.	State/Union Territories	Area (in sq.km) 1991		Density of Population per sq. km.			
		Total	Urban	Total		Urban	
1	2	3	4	1981	1991	1981	1991
1	ANDHRA PRADESH	275045	5171	195	242	3086	3459
2	ARUNACHAL PRADESH	83743	NA	10	10	NA	NA
3	ASSAM	78438	828	230	286	3307	3005
4	BIHAR	173877	3743	402	497	2726	3033
5	GOA	3702	385	272	316	1823	1246
6	GUJARAT	196024	5137	174	211	2225	2773
7	HARYANA	44212	967	292	372	3701	4193
8	HIMACHAL PRADESH	55673	270	77	93	1538	1664
9	JAMMU & KASHMIR	222236	NA	59	76	1247	NA
10	KARNATAKA	191791	4270	194	235	2913	3257
11	KERALA	38863	3365	655	749	2668	2282
12	MADHYA PRADESH	443446	7908	118	149	2170	1940
13	MAHARASHTRA	307713	6228	204	257	3735	4904
14	MANIPUR	22327	145	64	82	2470	3494
15	MEGHALAYA	22429	154	60	79	2839	2143
16	MIZORAM	21081	493	23	33	381	645
17	NAGALAND	16579	147	47	73	1103	1416
18	ORISSA	155707	2544	169	203	1359	1665
19	PUNJAB	50362	1440	333	403	3876	4162
20	RAJASTHAN	342239	4864	100	129	1603	2070
21	SIKKIM	7096	NA	45	57	NA	NA
22	TAMIL NADU	130058	6176	372	429	2722	3089
23	TRIPURA	10486	147	196	263	4177	2869
24	UTTAR PRADESH	294411	5603	377	473	4364	4872
25	WEST BENGAL	88752	3078	615	767	5460	6078
26	A & N ISLANDS	8249	14	23	34	3545	5354
27	CHANDIGARH	114	78	3961	5632	6218	7382
28	DADRA & NAGAR HAVELI	491	7	211	282	988	1675
29	DAMAN & DIU	112	23	705	907	NA	2067
30	DELHI	1483	685	4194	6352	9744	12367
31	LAKSHADWEEP	32	13	1258	1616	1694	2239
32	PONDICHERY	492	142	1229	1642	3160	3641
INDIA		3287263	64026	216	267@	NA	3370

- (i) Includes areas under the illegal occupation of Pakistan and China while working out the density of population.
- (ii) 1991 census was not held in J&K. For calculating density of India, the population figures for 1991 for J&K as projected by Standing Committee of Experts in population projections, (October, 1989) have been used.

Source : (i) Census of India - 1981 - Part II(B)(i) - Primary census abstract - General Population Tables.
(ii) Census of India - 1991 - series - I paper- 2-of 1992

TABLE NO. 1.10

Sex Ratio States and Union Territories 1981 and 1991

		Sex Ratio (Females/1000 males)			
Sno.	State/Union Territories	Total		Urban	
		1981	1991	1981	1991
1	2	3	4	5	6
1	ANDHRA PRADESH	975	972	948	959
2	ARUNACHAL PRADESH	862	859	629	728
3	ASSAM	901	923	768	838
4	BIHAR	946	941	832	844
5	GOA	975	967	906	930
6	GUJARAT	942	934	905	907
7	HARYANA	870	865	849	868
8	HIMACHAL PRADESH	973	976	795	831
9	JAMMU & KASHMIR	892	NA	875	NA
10	KARNATAKA	963	960	926	930
11	KERALA	1032	1036	1021	1034
12	MADHYA PRADESH	941	931	884	893
13	MAHARASHTRA	937	934	850	875
14	MANIPUR	971	958	969	975
15	MEGHALAYA	954	955	904	910
16	MIZORAM	919	921	893	932
17	NAGALAND	863	886	688	749
18	ORISSA	981	971	859	866
19	PUNJAB	879	882	865	868
20	RAJASTHAN	919	910	877	879
21	SIKKIM	835	878	697	750
22	TAMIL NADU	977	974	956	960
23	TRIPURA	946	945	957	958
24	UTTAR PRADESH	885	879	846	860
25	WEST BENGAL	911	917	819	858
26	A & N ISLANDS	760	818	720	769
27	CHANDIGARH	769	790	775	810
28	DADRA & NAGAR HAVELI	974	952	884	817
29	DAMAN & DIU	1062	969	1079	1024
30	DELHI	808	827	808	830
31	LAKSHADWEEP	975	943	963	930
32	PONDICHERRY	985	979	992	985
	INDIA	935	927	880	894

Source : Final Population Totals Series - I
Paper - 2 of 1992 census of India - 1991

Table 1.11
Age distribution of population in India - 1981

Age Group	Population in (000's)			Percentage distribution		
	Male	Female	Persons	Male	Female	Persons
1	2	3	4	5	6	7
0-4	42228	41282	83510	12.28	12.85	12.55
5-9	48268	45418	93686	14.03	14.13	14.18
10-14	45265	40646	85911	13.16	12.15	12.91
15-19	34027	30112	64139	9.89	9.37	9.64
20-24	29000	28338	57338	8.43	8.82	8.62
25-29	25755	24970	50725	7.49	7.77	7.62
30-34	21579	20800	42379	6.28	6.47	6.37
35-39	19899	18960	38859	5.79	5.90	5.84
40-44	18033	16154	34187	5.24	5.03	5.14
45-49	15379	13866	29239	4.47	4.30	4.39
50-54	13794	11603	25397	4.01	3.61	3.82
55-59	8498	7919	16417	2.47	2.46	2.47
60-64	9385	8782	18167	2.73	2.73	2.73
65-69	4794	4721	9515	1.39	1.47	1.43
70+	8033	7788	15821	2.34	2.42	2.38
TOTAL	343930	321357	665287	100.00	100.00	100.00

Note : The total of percentages may not add to 100 because of round up of figures
Source: Census of India 1981 - Series-I
Part-IVA-Social and Cultural Tables

AGE WISE DISTRIBUTION OF POPULATION INDIA 1981

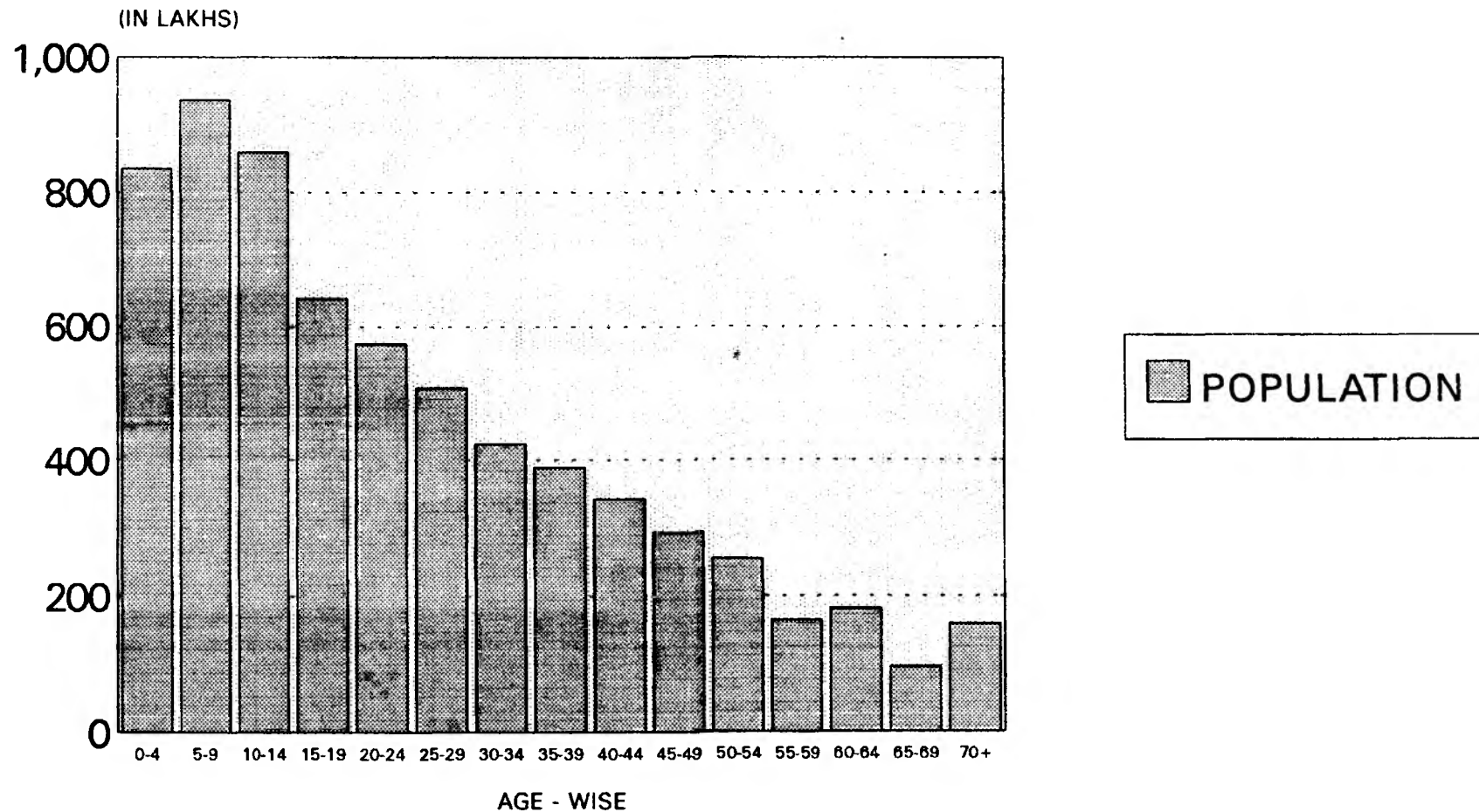

SOURCE : CENSUS OF INDIA 1981
TOT. OF FIGS MAY NOT TALLY TO TOT POP.
CMIS/(2)/HBOOK.HG3

TABLE NO. 1.12

Population of scheduled Castes and Scheduled Tribes as per Census - 1991

(Figures in thousand)

S.no.	State/UTs	TOTAL						URBAN					
		Scheduled Caste			Scheduled Tribe			Scheduled Caste			Scheduled Tribe		
		Persons	Male	Female	Persons	Male	Female	Persons	Male	Female	Persons	Male	Female
1	2	3	4	5	6	7	8	9	10	11	12	13	14
1	ANDHRA PRADESH	10592066	5378654	5212412	419481	2142817	2056664	1833425	927872	905553	319227	166667	152560
2	ARUNACHAL PRADESH	4052	2491	1561	550351	275397	274954	1194	709	485	32129	16802	15327
3	ASSAM	1659412	864617	794795	2874441	1461560	1412881	229281	120783	108498	97133	52196	45937
4	BIHAR	12571700	6569360	6002340	6616914	3357563	3259351	1134564	611174	523390	463255	241739	221516
5	GOA	24364	12389	11975	376	199	177	11617	5910	5707	287	151	136
6	GUJARAT	3060358	1589686	1470672	6162	3132	3030	1160964	608305	552659	498597	258993	239604
7	HARYANA	3250933	1747821	1503112	0	0	0	575656	309531	266125	0	0	0
8	HIMACHAL PRADESH	1310296	666055	644241	218349	110240	108109	82975	44649	38326	5409	3078	2331
9	JAMMU & KASHMIR	N.A.	N.A.	N.A.	N.A.	N.A.	N.A.	N.A.	N.A.	N.A.	N.A.	N.A.	N.A.
10	KARNATAKA	7369279	3756069	3613210	1915691	976744	938947	1724093	886815	837278	286195	147615	138580
11	KERALA	2886522	1422614	1463908	320967	160812	160155	534598	263130	271468	11203	5833	5370
12	MADHYA PRADESH	9626679	5027806	4598873	15399034	7758174	7640860	2104285	1107683	996602	746304	392481	353823
13	MAHARASHTRA	8757842	4505375	4252467	7318281	3717193	3600498	3205838	1668396	1537442	912467	476001	436466
14	MANIPUR	37105	18806	18299	632173	322720	309453	19400	9731	9669	53243	27029	26214
15	MEGHALAYA	9072	4981	4091	157927	760234	757693	4100	2284	1816	205834	100375	105459
16	MIZORAM	691	577	94	653565	329819	323746	235	198	37	295452	147607	147845
17	NAGALAND	0	0	0	1060822	545156	515666	0	0	0	127697	66577	61100
18	ORISSA	5129314	2596464	2532850	7032214	3512891	3519323	550645	285080	265565	362708	187449	174259
19	PUNJAB	5742528	3065671	2676857	0	0	0	1180086	629876	550210	0	0	0
20	RAJASTHAN	7607820	4007220	3600600	5474881	2837014	2637867	1505324	797176	708148	254332	140577	113755
21	SIKKIM	24084	12424	11660	90901	47504	43397	2751	1411	1340	7415	4627	3388
22	TAMIL NADU	10712266	5414599	5297667	574194	293012	281182	2284226	1155229	1128997	68986	35159	33827
23	TRIPURA	451116	231516	219600	853345	434225	419120	71452	36437	35015	14081	7484	6597
24	UTTAR PRADESH	29276455	15599178	13677277	287901	150420	137481	3453067	1862743	1590324	16873	9271	7602
25	WEST BENGAL	16080611	8326832	7753779	3808760	1938955	1869805	2475206	1308243	1166963	196312	103396	92906
26	A & N ISLANDS	0	0	0	26770	13750	13020	0	0	0	502	314	188
27	CHANDIGARH	105977	58554	47423	0	0	0	91837	50464	41373	0	0	0
28	DADRA & NAGAR HAVE	2730	1418	1312	109380	54102	55278	487	258	229	3516	1798	1718
29	DAMAN & DIU	3891	1882	2009	11724	6073	5651	1496	738	758	2532	1290	1242
30	DELHI	1794336	978690	816146	0	0	0	1587127	864729	722398	0	0	0
31	LAKSHADWEEP	0	0	0	48163	24160	24003	0	0	0	26685	13432	13253
32	PONDICHERRY	131278	66191	65087	0	0	0	53551	26987	26564	0	0	0
	INDIA	138223277	71928960	66294317	67758380	34363271	33395109	25879480	13586541	12292939	5007354	2607341	2400013

Note: Due to rounding up of figures, total for India do not tally.

Source : Census of India 1991 Series - 1

Final Population Totals, Paper - 2 of 1992

CHAPTER -II

LITERACY RATES

TABLE NOs 2.1 TO 2.7

TABLE NO. 2.1

Literacy Rate - States and union Territories - 1971, 1981 and 1991

		Total							
		1971		1981		1981(a)		1991	
Sno.	State/Union Territories	No. of Literates	Literacy Rate	No. of Literates	Literacy Rate	Literacy Rate (a)	No. of Literates	Literacy Rate	
1	2	3	4	5	6	7	8	9	
1	ANDHRA PRADESH	10689665	24.57	16034818	29.94	35.66	24487559	44.09	
2	ARUNACHAL PRADESH	52791	11.29	131333	20.79	25.55	283610	41.59	
3	ASSAM	4295564	28.72	0	+++	+++	9516393	52.89	
4	BIHAR	11237613	19.94	18321004	26.20	32.05	26402898	38.48	
5	GOA	383864	44.75	615752	56.66	65.71	779596	75.51	
6	GUJARAT	9555289	35.79	14895844	43.70	52.21	21131404	61.29	
7	HARYANA	2699179	26.89	4669898	36.13	43.88	7449012	55.85	
8	HIMACHAL PRADESH	1105825	31.96	1818287	42.47	51.18	2765409	63.86	
9	JAMMU & KASHMIR	857964	18.58	1596776	26.67	26.67	+++	+++	
10	KARNATAKA	9235127	31.52	14282717	38.46	46.21	21013193	56.04	
11	KERALA	12898072	60.42	17924732	70.42	81.56	22686461	89.81	
12	MADHYA PRADESH	9223081	22.14	14544568	27.87	34.23	23665301	44.20	
13	MAHARASHTRA	19753608	39.18	29620806	47.18	55.83	42447139	64.87	
14	MANIPUR	353090	32.91	587618	41.35	49.66	916692	59.89	
15	MEGHALAYA	298312	29.49	455191	34.08	42.05	678105	49.10	
16	MIZORAM	*	53.79	295685	59.88	74.26	461930	82.27	
17	NAGALAND	141518	27.40	329878	42.57	50.28	617736	61.65	
18	ORISSA	5745399	26.18	9027205	34.23	40.97	12915917	49.09	
19	PUNJAB	4562123	33.67	6860349	40.86	48.17	9932116	58.51	
20	RAJASTHAN	4914293	19.07	8354117	24.38	30.11	13549088	38.55	
21	SIKKIM	0	17.74	107738	34.05	41.59	188920	56.94	
22	TAMIL NADU	16256393	39.46	22637659	46.76	54.39	30336235	62.66	
23	TRIPURA	282082	30.98	864799	42.12	50.11	1365980	60.44	
24	UTTAR PRADESH	19173970	21.77	30105260	27.16	33.35	46144186	41.60	
25	WEST BENGAL	14711739	33.20	22344153	40.94	48.65	32609397	57.70	
26	A & N ISLANDS	50191	43.59	97321	51.56	63.19	171086	73.02	
27	CHANDIGARH	158371	61.56	292580	64.78	74.81	425060	77.81	
28	DADRA & NAGAR HAVELI	11105	14.97	27655	26.67	32.70	44834	40.71	
29	DAMAN & DIU	217058	46.02	337615	55.85	59.91	61096	71.20	
30	DELHI	2301605	56.61	3828326	61.54	71.94	5882297	75.29	
31	LAKSHADWEEP	13889	43.66	22165	55.07	68.42	34548	81.78	
32	PONDICHERRY	217058	46.02	337615	55.85	65.14	521213	74.74	
INDIA		161377780	29.46	241031849	36.23	43.67	359284417	52.21	

* INCLUDED IN GOA

** INCLUDED IN ASSAM

@ EXCLUDES 0-6 AGE GROUP POPULATION.

+++ CENSUS WAS NOT HELD IN J&K

SOURCE : (i) Census of India - 1971 Series - I Part - IVA Social & Cultural Tables
(ii) Census of India - 1981 Series - I Part - IVA Social & Cultural Tables
(iii) Census of India - 1991 Series - I Paper - 2 Final Population Totals

TABLE NO. 2.1

Literacy Rate - States and union Territories - 1971, 1981 and 1991

		Urban					
		1971		1981		1991	
Sno.	State/Union Territories	No. of Literates	Literacy Rate	No. of Literates	Literacy Rate	No. of Literates	Literacy Rate
1	2	10	11	12	13	14	15
1	ANDHRA PRADESH	3955667	47.08	6492568	51.99	10049306	66.35
2	ARUNACHAL PRADESH	8724	50.46	22050	53.22	64552	71.59
3	ASSAM	778836	58.69	++++	++++	1697843	79.39
4	BIHAR	2530541	44.92	4549859	52.18	63574680	67.89
5	GOA	127729	56.32	228625	64.98	339359	80.10
6	GUJARAT	4115894	54.90	6394058	60.31	9224106	76.54
7	HARYANA	904254	51.00	1607743	56.86	2474086	73.66
8	HIMACHAL PRADESH	146450	60.54	219840	67.44	327200	84.17
9	JAMMU & KASHMIR	327610	38.17	574293	45.56	+++	+++
10	KARNATAKA	3662937	51.43	6084804	56.71	8762573	74.20
11	KERALA	2298863	66.31	3631315	76.10	6203553	92.25
12	MADHYA PRADESH	3361666	49.55	5718612	53.96	8962354	70.81
13	MAHARASHTRA	9123909	58.07	14058085	63.91	20460597	79.20
14	MANIPUR	75334	53.24	196894	52.44	300735	70.53
15	MEGHALAYA	96985	65.22	154734	64.11	223270	81.74
16	MIZORAM	++++	++++	90216	74.06	245063	93.45
17	NAGALAND	31241	60.79	77223	64.22	142170	83.10
18	ORISSA	904215	49.00	1703586	54.77	2591539	71.99
19	PUNJAB	1688220	52.49	2585523	55.62	3633473	72.08
20	RAJASTHAN	1976088	43.47	3486536	48.35	5370395	65.33
21	SIKKIM	++	++	28024	54.85	25848	80.89
22	TAMIL NADU	7024806	56.36	10121436	63.44	13024074	77.99
23	TRIPURA	103933	69.01	166156	73.66	303345	83.09
24	UTTAR PRADESH	6404708	44.10	9130462	45.88	13739707	61.00
25	WEST BENGAL	6133785	55.93	9052976	62.66	12370562	75.27
26	A & N ISLANDS	16132	61.53	32528	65.53	52633	81.69
27	CHANDIGARH	160949	64.80	279712	66.15	393107	79.87
28	DADRA & NAGAR HAVELI	0	0.00	3745	54.16	7732	78.44
29	DAMAN & DIU	+	+	+	+	33687	81.61
30	DELHI	2149915	58.95	3613235	62.64	5380149	76.18
31	LAKSHADWEEP	0	0.00	10926	58.65	20148	83.99
32	PONDICHERRY	111605	56.23	199221	63.03	359696	79.88
	INDIA	57208695	52.49	90514985	57.40	133140330	73.08

+ INCLUDED IN GOA

** INCLUDED IN ASSAM

+++ CENSES WAS NOT NOT HELD J&K

++ SIKKIM WAS NOT PART OF INDIA

++++ CENSUS WAS NOT HELD IN ASSAM

SOURCE : (i) Census of India - 1971 Series - I Part - IVA Social & Cultural Tables

(ii) Census of India - 1981 Series - I Part - IVA Social & Cultural Tables

(iii) Census of India - 1991 Series - I Paper - 2 Final Population Totals

TABLE NO. 2.2

Effective Literacy Rates 1971, 1981 & 1991

S.no.	State/UTs	1961-literacy Rates (Excluding 0-4 age Group)			1971-Literacy Rates (Excluding 0-4 age Group)			1981 - Literacy Rates (Excluding 0-4 age Group)			1991 - Literacy Rate (Excluding 0-7 age Group)		
		Total	Male	Female	Total	Male	Female	Total	Male	Female	Total	Male	Female
1	2	3	4	5	6	7	8	9	10	11	12	13	14
1	ANDHRA PRADESH	25.05	35.58	14.25	28.52	38.43	18.32	34.08	44.61	23.25	44.09	55.13	32.7
2	ARUNACHAL PRADESH	NA	NA	NA	13.26	20.63	4.43	24.24	33.35	13.39	41.59	51.45	29.6
3	ASSAM	33.70	45.21	20.09	34.60	44.31	23.52	***	***	***	52.89	61.85	43.0
4	BIHAR	22.24	36.06	8.33	23.35	35.78	10.24	30.25	43.79	15.80	38.48	52.49	22.8
5	GOA	NA	NA	NA	51.48	62.61	40.27	63.12	73.13	52.93	75.51	83.64	67.0
6	GUJARAT	36.78	49.60	23.10	41.84	53.78	29.00	49.89	62.06	36.93	61.29	73.13	48.6
7	HARYANA	*	*	*	31.91	44.02	17.77	43.88	58.51	26.93	55.85	69.10	40.4
8	HIMACHAL PRADESH	20.11	31.77	7.36	37.30	50.32	23.67	48.74	61.03	36.10	63.86	75.36	52.1
9	JAMMU & KASHMIR	13.20	20.11	5.16	21.71	31.01	10.94	30.64	41.45	18.36	+	+	+
10	KARNATAKA	30.53	43.29	17.12	36.83	48.51	24.55	43.92	55.67	31.68	56.04	67.24	44.3
11	KERALA	55.64	65.61	45.98	69.72	77.13	62.53	78.84	84.55	73.35	89.81	93.62	86.1
12	MADHYA PRADESH	20.79	32.68	8.21	26.37	38.77	13.08	34.36	45.50	22.62	44.20	58.42	28.8
13	MAHARASHTRA	35.50	49.80	20.07	45.77	59.40	31.00	53.58	66.29	40.26	64.87	76.56	52.3
14	MANIPUR	36.85	54.96	19.21	38.47	53.70	22.87	47.44	61.05	33.39	59.89	71.63	47.6
15	MEGHALAYA	*	*	*	35.06	40.44	29.31	39.95	44.26	35.40	49.10	53.12	44.8
16	MIZORAM	*	*	*	*	*	*	69.90	74.77	64.53	82.27	85.61	78.6
17	NAGALAND	21.37	28.59	13.58	31.32	39.65	51.56	48.20	56.20	38.76	61.65	67.62	54.7
18	ORISSA	25.69	41.04	10.28	30.53	44.50	16.29	48.97	56.45	25.14	49.09	63.09	34.6
19	PUNJAB	29.18	34.55	17.07	38.69	46.22	29.91	40.17	55.56	39.70	58.51	65.66	50.4
20	RAJASTHAN	18.40	28.56	7.00	22.57	33.87	10.06	28.37	42.03	13.15	38.55	54.99	20.4
21	SIKKIM	14.82	23.31	5.18	20.22	28.52	10.31	39.57	50.49	26.16	56.94	65.74	46.6
22	TAMIL MADU	36.77	52.51	21.27	45.40	59.54	30.92	0.00	0.00	0.00	62.66	73.75	51.3
23	TRIPURA	24.66	35.83	12.50	36.19	46.84	24.84	47.64	58.34	36.27	60.44	70.58	49.6
24	UTTAR PRADESH	21.13	32.63	8.43	25.44	36.69	12.46	31.37	44.49	16.33	41.60	56.73	25.3
25	WEST BENGAL	35.31	47.69	20.79	38.86	49.57	26.56	46.32	57.03	34.42	57.70	67.81	46.5
26	A & N ISLANDS	40.51	40.10	24.99	51.15	58.82	38.29	60.24	67.31	50.51	73.02	78.99	65.4
27	CHANDIGARH	*	*	*	70.43	75.74	63.15	73.44	77.42	68.15	77.81	82.04	72.3
28	DADRA & NAGAR HAVELI	11.68	17.97	5.04	18.12	26.79	9.50	31.24	42.44	19.69	40.71	53.56	26.9
29	DAMAN & DIU	NA	NA	NA	**	**	**	**	**	**	71.20	82.66	59.4
30	DELHI	62.60	71.07	51.54	65.08	72.05	55.56	69.93	76.99	61.01	75.29	82.01	66.9
31	LAKSHADWEEP	28.03	43.38	13.10	51.76	67.33	36.03	63.96	75.79	51.84	81.78	90.18	72.8
32	PONDICHERRY	43.85	59.16	28.80	53.38	66.50	40.14	63.17	74.47	51.90	74.74	83.68	65.6
	INDIA	28.79++	41.14++	15.57++	34.45	45.95	21.97	41.44	53.48	28.47	52.21	64.13	39.29

* The data are included in the states of which these states formed part in 1961 and 1971 respectively.

** Included in Goa

*** Excludes Assam for 1981

+ Census was not conducted in j&k

++ Excludes Goa, Daman & Diu and M.E.F.A. (Arunachal Pradesh)

Source : (i) Social & Cultural Tables of Census of India - 1961, 1971, 1981

(ii) Final Population Totals Paper - 2 of 1992 Census of India - 1991

TABLE NO. 2.3

Literacy position of different age-groups and by sex in 1971 and 1981 - India

(Figures in lakhs)

		1971					1981						
		Literates			Illiterates		Literates			Illiterates			
Sno.	Age Group	Persons	Male	Female	Persons	Male	Female	Persons	Male	Female	Persons	Male	Female
1	2	3	4	5	6	7	8	9	10	11	12	13	14
5 - 9		189.00 (23.13)	114.66 (27.16)	75.04 (18.86)	630.34 (76.87)	307.50 (72.84)	322.84 (81.14)	286.20 (30.57)	169.16 (35.06)	117.04 (25.79)	650.19 (69.43)	313.39 (64.94)	336.80 (74.21)
10 - 14		341.29 (49.62)	218.15 (59.78)	123.14 (38.15)	346.45 (53.38)	145.77 (40.22)	199.68 (61.85)	487.45 (56.48)	305.87 (66.90)	181.58 (44.85)	372.90 (43.52)	149.58 (33.10)	223.32 (55.15)
15 - 24		436.50 (48.19)	290.78 (62.14)	145.72 (33.29)	469.19 (51.81)	177.17 (37.86)	292.02 (66.71)	652.65 (53.79)	416.79 (66.32)	235.86 (40.33)	50.80 (46.21)	211.71 (33.68)	349.09 (59.67)
25 - 34		267.86 (34.79)	193.85 (50.14)	74.01 (19.30)	502.18 (65.21)	192.75 (49.86)	309.43 (80.70)	420.29 (45.10)	287.51 (60.73)	132.78 (28.97)	511.61 (54.90)	185.97 (39.27)	325.64 (71.03)
35 +		378.40 (25.21)	302.76 (38.02)	75.64 (10.73)	1112.93 (74.79)	493.54 (61.98)	629.39 (89.27)	565.53 (30.19)	436.02 (44.62)	129.51 (14.45)	1308.38 (69.81)	541.13 (55.38)	767.25 (85.55)
Age not stated		0.35 (30.17)	0.22 (39.29)	0.13 (21.67)	0.81 (69.83)	0.34 (60.71)	0.47 (78.33)	1.80 (64.75)	1.12 (70.88)	0.68 (56.62)	0.98 (35.28)	0.46 (29.12)	0.52 (43.28)
Total(excluding 0-4)		1614.15 (34.45)	1120.44 (45.95)	493.71 (21.97)	3071.88 (65.55)	1318.05 (54.05)	1753.83 (78.03)	2410.32 (41.44)	1612.86 (53.48)	797.46 (28.47)	3405.05 (58.56)	1402.42 (46.52)	2002.83 (71.53)

Figures in parenthesis indicate percentage to the corresponding population.

Source : (i) Census of India - 1981 - series - 1 Social & Cultural Tables Part - IVA.

(ii) Census of India - 1971 - series - 1 Social & Cultural Tables.

TABLE NO. 2.4

Literacy position of the population in age-group 15-35 by sex and Urban/Rural areas in 1971 and 1981 - India

(Figures in lakhs)

Year	Area	No of Illiterates			No of literates		
		Persons	Male	Female	Persons	Male	Female
1	2	3	4	5	6	7	8
1971	Total	971.36 (57.97)	369.91 (43.29)	601.45 (73.24)	704.38 (42.03)	484.64 (56.71)	219.74 (26.76)
	Urban	119.28 (31.40)	44.69 (21.47)	74.79 (43.33)	260.54 (68.66)	162.72 (78.53)	97.82 (56.67)
	Rural	852.08 (65.75)	325.42 (50.27)	526.66 (81.20)	443.84 (34.25)	321.92 (49.73)	121.92 (18.80)
1981	Total	1072.41 (49.98)	397.68 (36.08)	674.73 (64.66)	1072.94 (50.02)	704.30 (63.92)	368.64 (35.34)
	Urban	155.31 (26.90)	57.22 (18.46)	98.09 (36.69)	421.94 (73.10)	252.71 (81.54)	169.23 (63.31)
	Rural	917.09 (58.49)	340.46 (42.98)	576.64 (74.30)	651.00 (41.51)	451.59 (57.02)	199.41 (25.70)

Note: Figures in paranthesis indicate percentage to the corresponding population
 Source : (i) Census of India - 1981 - series - 1 Social & Cultural Tables Part -
 (ii) Census of India - 1971 - series - 1 Social & Cultural Tables.

TABLE NO. 2.5

Statewise Literacy Position of the adult population aged 15 and over in 1971 and 1981

(Figures in lakhs)

Sno.	State/Union Territories	1971			1981		
		Total Population	Number of Literates	Percentage Literates	Total Population	Number of Literates	Percentage Literates
1	2	3	4	5	6	7	8
1	ANDHRA PRADESH	258.94	73.17	28.26	328.87	106.87	32.50
2	ASSAM	77.59	27.55	35.51	*	*	*
3	BIHAR	323.00	76.09	23.51	407.55	119.60	29.33
4	GUJARAT	152.02	63.85	42.00	208.66	100.71	48.26
5	HARYANA	53.97	16.05	29.74	75.20	29.45	39.16
6	HIMACHAL PRADESH	20.34	6.56	32.27	25.85	11.30	43.72
7	JAMMU & KASHMIR	26.36	5.58	21.15	37.41	12.68	33.89
8	KARNATAKA	168.64	60.58	35.92	224.20	96.49	43.04
9	KERALA	127.52	88.18	69.15	165.50	129.28	78.11
10	MADHYA PRADESH	234.51	62.41	26.61	306.41	99.20	32.35
11	MAHARASHTRA	295.72	132.90	44.94	386.29	200.23	51.18
12	MANIPUR	6.17	2.36	38.30	8.47	3.91	46.13
13	MEGHALAYA	5.71	2.15	36.66	7.68	3.23	42.03
14	NAGALAND	3.21	1.05	32.90	4.87	2.39	49.03
15	ORISSA	126.50	39.27	31.04	153.07	61.57	38.71
16	PUNJAB	79.57	28.02	35.22	105.81	45.05	42.57
17	RAJASTHAN	143.85	31.63	21.98	196.98	55.50	28.18
18	SIKKIM	1.29	0.31	24.42	1.91	0.76	39.61
19	TAMIL NADU	256.37	110.08	42.94	314.58	158.47	50.38
20	TRIPURA	8.69	3.27	37.62	12.45	6.01	48.24
21	UTTAR PRADESH	513.76	125.83	24.49	646.39	198.68	30.74
22	WEST BENGAL	253.04	102.50	40.51	333.77	160.62	48.12
23	A & N ISLANDS	0.71	0.36	50.46	1.14	0.67	58.89
24	ARUNACHAL PRADESH	2.89	0.41	14.09	3.83	0.91	23.72
25	CHANDIGARH	1.68	1.18	70.56	3.01	2.18	72.55
26	DADRA & NAGAR HAVELI	0.40	0.07	16.36	0.60	0.17	27.48
27	DELHI	24.95	16.12	64.62	40.03	27.59	68.92
28	GOA, DAMAN & DIU	5.31	2.67	50.31	7.04	4.27	60.64
29	LAKSHADWEEP	0.19	0.10	53.14	0.24	0.15	63.93
30	MIZORAM	1.89	1.40	74.53	2.97	2.25	75.86
31	PONDICHEERY	2.85	1.44	50.32	3.84	2.32	60.53
INDIA		3178.25	1083.14	34.08	4019.45	1741.80	43.33

Source Census of India Part-IV A Social and Cultural Tables - 1971 & 1981

TABLE NO. 2.6

Statewise Literacy Position in the age group 15-35 in 1981

(Figures in lakhs)

Sno.	State/Union Territories	Population			No of Illiterates			No of Literates			Percentage of literacy		
		Persons	Male	Female	Persons	Male	Female	Persons	Male	Female	Persons	Male	Female
1	2	3	4	5	6	7	8	9	10	11	12	13	14
1	ANDHRA PRADESH	170.00	85.35	84.65	102.63	41.49	61.14	67.37	43.86	23.51	39.63	51.39	27.77
2	ASSAM	N.A.	N.A.	N.A.	N.A.	N.A.	N.A.	N.A.	N.A.	N.A.	N.A.	N.A.	N.A.
3	BIHAR	211.13	106.42	104.71	135.64	50.16	85.48	75.49	56.26	19.23	35.76	52.87	18.37
4	GUJARAT	117.75	60.39	57.36	50.67	17.66	32.80	67.08	42.73	24.56	56.97	70.76	42.82
5	HARYANA	43.07	23.12	19.95	21.35	7.49	13.86	21.72	15.62	6.10	50.48	67.57	30.58
6	HIMACHAL PRADESH	13.65	6.66	6.99	5.34	1.55	3.79	8.31	5.11	3.20	60.88	76.73	45.78
7	JAMMU & KASHMIR	19.53	10.27	9.26	11.69	4.65	7.04	7.84	5.62	2.22	40.14	54.72	23.97
8	KARNATAKA	121.86	61.90	59.96	59.29	22.34	36.95	62.57	39.56	23.01	51.35	63.91	38.38
9	KERALA	92.98	44.94	48.04	10.08	3.22	6.85	82.90	41.72	41.19	89.16	92.83	85.74
10	MADHYA PRADESH	161.95	83.62	78.32	95.61	35.40	60.20	66.34	48.22	18.12	40.96	57.67	23.14
11	MAHARASHTRA	204.40	106.61	97.79	2.04	0.63	1.40	130.90	83.12	47.79	58.11	75.20	40.43
12	MANIPUR	4.87	2.54	2.35	2.30	1.02	1.28	2.86	1.91	0.95	48.89	54.05	43.86
13	MEGHALAYA	4.50	2.22	2.28	1.06	0.45	0.62	2.20	1.20	1.00	62.41	70.78	51.56
14	MIZORAM	2.82	1.54	1.28	0.00	0.00	0.00	1.76	1.09	0.66	0.00	0.00	0.00
15	ORISSA	83.10	41.75	41.35	44.52	15.77	28.75	38.57	25.97	12.60	46.42	62.21	30.48
16	PUNJAB	58.62	31.08	27.54	27.63	11.42	14.21	33.00	19.67	13.33	56.28	63.27	48.40
17	RAJASTHAN	107.31	56.32	50.99	68.87	26.52	42.35	38.44	29.80	8.64	35.82	52.91	16.94
18	SIKKIM	1.17	0.65	0.52	0.63	0.27	0.36	0.52	0.39	0.15	46.40	59.36	30.04
19	TAMIL NADU	163.37	81.12	82.25	63.67	20.80	42.87	99.70	60.32	39.38	61.03	74.36	47.87
20	TRIPURA	6.91	3.51	3.40	3.06	1.16	1.90	3.85	2.35	1.50	55.72	66.95	44.12
21	WEST BENGAL	330.83	173.76	157.07	198.15	73.46	124.69	132.68	100.30	32.38	40.11	57.72	20.62
22	ANDAMAN & NICOBAR ISLANDS	0.70	0.40	0.30	0.23	0.10	0.13	0.47	0.31	0.17	67.14	75.25	56.67
23	CHHATTISGARH	2.08	1.13	0.95	1.40	0.61	0.78	0.69	0.52	0.17	32.98	45.97	17.56
24	CHHATTISGARH	1.90	1.09	0.81	0.43	0.21	0.22	1.47	0.88	0.59	77.33	80.35	73.39
25	DODRA & NAGAR HAVELI	0.34	0.17	0.17	0.22	0.08	0.14	0.12	0.09	0.04	36.05	51.18	21.26
26	DAMAN & DIU	24.32	13.73	10.59	6.09	2.52	3.57	18.23	11.21	7.02	74.96	81.65	66.29
27	LAKSHADWEEP	3.90	2.00	1.90	0.99	0.34	0.66	2.90	1.67	1.23	74.37	83.28	64.94
28	MIZORAM	0.13	0.06	0.07	0.02	0.00	0.02	0.11	0.06	0.05	83.59	95.08	73.13
29	MIZORAM	1.82	0.96	0.86	0.32	0.15	1.17	1.51	0.81	0.69	82.56	94.79	80.09
30	NAGALAND	2.08	1.04	1.04	0.58	0.18	0.40	1.51	0.87	0.64	72.40	83.21	61.61
		2145.34	1101.98	1043.37	969.08	294.35	674.73	1176.26	807.63	368.64	54.83	73.29	35.33

ANDHRA PRADESH was not held in 1981.

Source: Census of India - 1981 Part - IVA Social & Cultural Tables.

TABLE NO. 2.7
Statewise Literacy Position in the age group 15-35 in Rural and Urban Area in 1981

(Figure in Lakhs)

Sno.	State/Union Territories	RURAL AREAS						URBAN AREAS					
		Population			No of Literates			Population			No of Literates		
		Persons	Male	Female	Persons	Male	Female	Persons	Male	Female	Persons	Male	Female
		3	4	5	6	7	8	9	10	11	12	13	14
1	ANDHRA PRADESH	124.74	62.04	62.70	37.69	29.95	11.74	45.26	23.31	21.95	29.68	17.91	11.77
		-	-	-	(30.21)	(41.83)	(18.72)	-	-	-	(65.57)	(76.83)	(53.62)
2	ASSAM	-	-	-	-	-	-	-	-	-	-	(78.7)	(68.3)
3	BIHAR	181.46	89.97	91.49	55.79	43.80	12.40	29.67	16.45	13.22	19.61	12.78	6.83
		-	-	-	(30.75)	(48.68)	(13.55)	-	-	-	(66.09)	(77.68)	(51.66)
4	GUJARAT	77.32	39.16	38.46	36.90	24.86	12.05	40.13	21.23	18.90	30.38	17.87	12.51
		-	-	-	(47.72)	(63.48)	(31.33)	-	-	-	(75.70)	(84.17)	(66.19)
5	HARYANA	32.39	17.23	15.16	13.83	10.83	3.00	10.68	5.89	4.79	7.89	4.79	3.10
		-	-	-	(42.70)	(62.85)	(19.80)	-	-	-	(73.86)	(81.37)	(64.65)
6	HIMACHAL PRADESH	12.36	5.94	6.42	7.22	4.47	2.75	1.29	0.72	0.57	1.09	0.64	0.45
		-	-	-	(58.41)	(75.25)	(42.83)	-	-	-	(84.49)	(88.88)	(78.94)
7	JAMMU & KASHMIR	14.85	7.78	7.07	4.91	3.85	1.06	4.68	2.49	2.19	2.93	1.77	1.16
		-	-	-	(33.06)	(49.49)	(14.99)	-	-	-	(62.60)	(71.08)	(52.96)
8	KARNATAKA	82.46	41.23	41.23	34.04	22.84	11.20	39.40	20.67	18.73	28.53	16.72	11.81
		-	-	-	-	-	-	-	-	-	(72.41)	(80.89)	(63.05)
9	KERALA	74.77	36.01	38.76	65.89	33.19	32.71	18.21	8.93	9.28	17.01	8.53	8.48
		-	-	-	(88.12)	(92.17)	(84.39)	-	-	-	(93.41)	(95.52)	(91.37)
10	MADHYA PRADESH	124.07	63.11	60.95	39.20	31.12	8.08	37.88	20.51	17.37	27.14	17.10	10.04
		-	-	-	(31.60)	(49.31)	(13.26)	-	-	-	(71.64)	(83.37)	(57.80)
11	MAHARASHTRA	122.03	60.92	61.11	65.03	43.30	21.74	82.37	45.69	36.68	65.87	39.82	26.05
		-	-	-	(53.29)	(71.08)	(35.58)	-	-	-	(79.96)	(87.15)	(71.01)
12	MANIPUR	3.55	1.87	1.70	1.89	1.33	0.56	1.32	0.67	0.65	0.97	0.58	0.39
		-	-	-	(53.24)	(71.21)	(32.94)	-	-	-	(73.48)	(86.56)	(60.00)
13	MEGHALAYA	3.55	1.72	1.83	1.44	0.78	0.66	0.95	0.50	0.45	0.76	0.42	0.34
		-	-	-	(40.56)	(45.35)	(36.07)	-	-	-	(80.00)	(84.00)	(75.55)
14	NAGALAND	2.31	1.03	1.08	1.36	0.84	0.51	0.51	0.31	0.20	0.40	0.25	0.15
		-	-	-	(58.87)	(68.29)	(47.22)	-	-	-	(78.83)	(80.64)	(75.00)
15	ORISSA	71.94	35.63	36.31	30.73	21.00	9.73	11.16	6.11	5.04	7.84	4.97	2.87
		-	-	-	(42.72)	(58.9)	(26.8)	-	-	-	(70.3)	(81.3)	(56.86)
16	PUNJAB	41.16	21.67	19.49	20.67	12.53	7.8	17.46	9.41	8.05	12.67	7.14	5.53
		-	-	-	(50.2)	(57.8)	(40.0)	-	-	-	-	-	-

1	2	3	4	5	6	7	8	9	10	11	12	13	14
17	RAJASTHAN	81.66	42.18	39.48	21.79	18.66	3.13	25.65	14.14	11.51	16.65	11.14	5.51
		-	-	-	(26.68)	(44.24)	(7.93)	-	-	-	(64.91)	(78.78)	(47.87)
18	SIKKIM	0.94	0.51	0.43	0.38	0.28	0.10	0.23	0.14	0.09	0.16	0.11	0.05
		-	-	-	(40.32)	(54.90)	(23.26)	-	-	-	(69.56)	(78.57)	(55.55)
19	TAMIL NADU	104.96	51.58	53.38	53.07	34.24	18.83	58.40	29.53	28.87	46.63	26.08	20.55
		-	-	-	(50.6)	(59.4)	(35.2)	-	-	-	(79.8)	(88.4)	(71.2)
20	TRIPURA	6.02	3.06	2.96	3.05	1.93	1.12	0.89	0.45	0.44	0.80	0.42	0.38
		-	-	-	(50.66)	(63.07)	(37.84)	-	-	-	(89.88)	(93.93)	(86.36)
21	UTTAR PRADESH	262.42	136.01	58.53	90.73	73.43	17.30	68.41	37.75	30.66	41.95	26.87	15.08
		-	-	-	(34.57)	(53.99)	(29.56)	-	-	-	(61.32)	(71.17)	(49.18)
22	WEST BENGAL	133.70	69.54	64.14	60.71	40.46	20.25	55.06	30.03	25.03	41.42	24.10	17.32
		-	-	-	(45.41)	(58.16)	(31.57)	-	-	-	(75.22)	(80.25)	(69.19)
23	A & N ISLANDS	0.494	0.280	0.214	0.308	0.200	0.109	0.206	0.120	0.086	0.162	0.101	0.061
		-	-	-	(62.35)	(71.43)	(50.93)	-	-	-	(78.64)	(84.16)	(70.93)
24	ARUNACHAL PRADESH	1.892	1.008	0.884	0.562	0.431	0.131	0.188	0.121	0.067	0.124	0.088	0.036
		-	-	-	(29.70)	(42.76)	(14.82)	-	-	-	(65.95)	(72.72)	(53.73)
25	CHANDIGARH	0.117	0.069	0.048	0.067	0.045	0.023	1.78	1.02	0.76	1.40	0.83	0.57
		-	-	-	(57.26)	(65.22)	(47.92)	-	-	-	(78.65)	(81.37)	(75.0)
26	DADRA & NAGAR HAVELI	0.318	0.157	0.161	0.108	0.076	0.031	0.026	0.013	0.013	0.015	1.011	0.004
		-	-	-	(33.96)	(48.41)	(19.25)	-	-	-	(57.69)	(84.61)	(30.76)
27	DELHI	1.59	0.90	0.69	1.01	0.72	0.29	22.73	12.83	9.90	17.22	10.49	6.73
		-	-	-	(63.52)	(80.00)	(42.03)	-	-	-	(75.75)	(81.76)	(67.97)
28	GOA, DAMAN & DIU	2.538	1.283	1.254	1.80	1.03	0.76	1.36	0.72	0.64	1.10	0.62	0.48
		-	-	-	(71.15)	(80.30)	(60.80)	-	-	-	(80.88)	(86.11)	(75.00)
29	LAKSHADWEEP	0.066	0.031	0.035	0.54	0.29	0.25	0.062	0.030	0.032	0.053	0.029	0.024
		-	-	-	(81.82)	(93.55)	(71.13)	-	-	-	(85.48)	(96.66)	(75.00)
30	MIZORAM	1.326	0.691	0.635	1.037	0.560	0.477	0.498	0.269	0.229	0.469	0.254	0.215
		-	-	-	(78.21)	(81.04)	(46.00)	-	-	-	(94.17)	(94.42)	(93.88)
31	PONDICHERY	0.964	0.482	0.482	0.600	0.367	0.232	1.12	0.56	0.56	0.91	0.50	0.41
		-	-	-	(64.24)	(76.14)	(48.13)	-	-	-	(81.25)	(89.28)	(73.21)
	INDIA	1568.08	791.82	776.05	754.32	554.92	191.41	577.26	309.94	267.32	421.94	252.71	169.23
		-	-	-	(48.10)	(70.08)	(24.66)	-	-	-	(73.09)	(81.53)	(63.30)

Source : Census of India - 1981 Part - IVA Series - I Social & Cultural Tables.

CHAPTER -III

INSTITUTIONS & ENROLMENT

TABLE NOs 3.1 TO 3.5

TABLE - 3.1

Growth of Recognised Educational Institutions in India
during 1950-51 to 1994-95

Year	Primary/Junior Basic Schools	Middle/Senior Basic Schools	High/Hr.Sec Schools @
1	2	3	4
1950-51	209671	13596	7288
1960-61	330399	49663	17257
1961-62	351530	55915	19306
1962-63	366262	61377	21440
1963-64	377106	65588	22996
1964-65	385049	72153	25252
1965-66	391064	75798	27477
1966-67	396170	79616	30445
1967-68	399297	82924	31713
1968-69	400621	84246	33487
1969-70	403303	88113	35067
1970-71	408378	90621	36738
1971-72	417473	93665	38174
1972-73	431791	97623	39764
1973-74	437957	101917	44452
1974-75	450950	104545	42106
1975-76	554270	106571	43054
1976-77	457324	108602	43775
1977-78	462567	110035	45489
1978-79	472519	112801	46874
1979-80	482476	115117	48905
1980-81	494503	118555	51006
1981-82	503763	122377	53307
1982-83	511106	125446	56530
1983-84	516238	128358	58901
1984-85	521048	131249	62186
1985-86	528872	134846	65837
1986-87	530728	138030	68639
1987-88	539002	142565	71952
1988-89	542647	144715	72602
1989-90	548131	147159	74654
1990-91	560935	151456	79803
1991-92 (P)	565786	152077	79644
1992-93 (P)	572541	153923	81864
1993-94 (P)	572923	155787	85422
1994-95 (P)	581365	163605	92252

P Figures are provisional

@ Includes Intermediate/Pre-University/Jr. Colleges/Pre-degree Institutions

GROWTH OF RECOGNISED EDUCATIONAL INSTITUTIONS SINCE 1951 - SCHOOL LEVEL

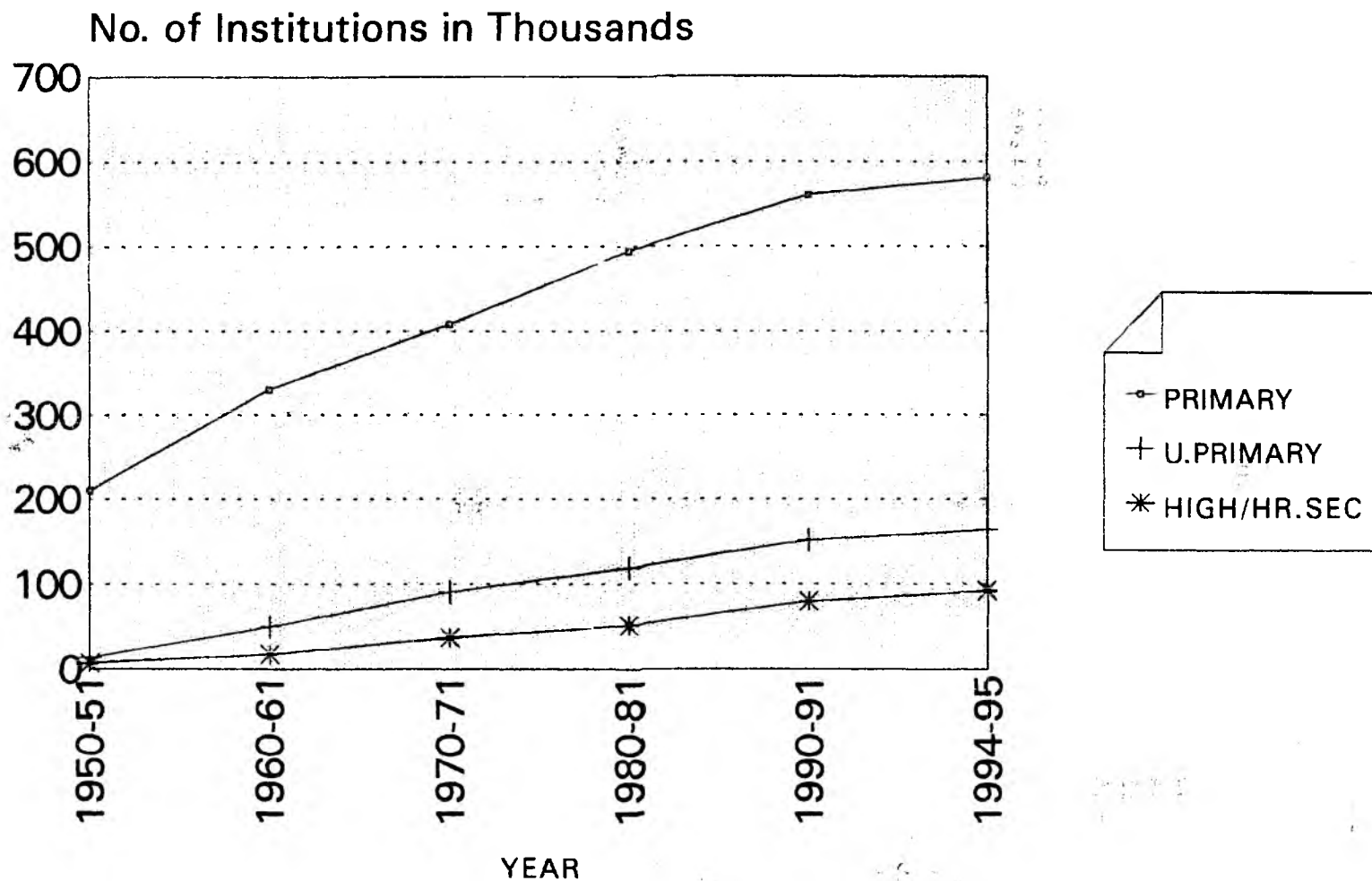

TABLE NO - 3.2

Statewise Number of Educational Institutions in India -
1970-71, 1980-81 and 1990-91

Sno.	State/Union Territories	Primary Schools			Middle Schools			High/Hr Secondary Schools		
		1970 71	1980-81	1990-91	1970-71	1980-81	1990-91	1970-71	1980-81	1990-91
1	2	3	4	5	6	7	8	9	10	11
1	ANDHRA PRADESH	37013	40611	48731	3123	4621	6118	2914	3836	5882
2	ARUNACHAL PRADESH	503	845	1122	47	117	255	16	44	114
3	ASSAM	17723	21723	27712	3092	4194	6262	1350	1994	3432
4	BIHAR	46823	50980	52932	8133	11289	13184	2598	3244	4022
5	GOA	765	967	1014	204	147	111	182	257	373
6	GUJARAT	10810	11199	13720	10545	13877	17559	2263	3153	5122
7	HARYANA	4204	4934	5114	760	881	1399	975	1473	2356
8	HIMACHAL PRADESH	3768	6093	7471	742	1032	1066	435	665	1125
9	JAMMU & KASHMIR	4872	7406	9242	1454	2046	2438	561	813	1220
10	KARNATAKA	21717	22523	23695	10817	12620	16512	2002	2678	5414
11	KERALA	6888	6861	6767	2544	2753	2915	1389	2273	2627
12	MADHYA PRADESH	36980	57018	68167	5851	10031	14719	1655	2195	4500
13	MAHARASHTRA	28533	35498	39084	16749	15547	18656	5200	6119	9972
14	MANIPUR	2472	2860	3189	384	425	687	123	290	430
15	MEGHALAYA	2528	3918	4232	211	473	792	81	204	402
16	MIZORAM	*	655	1109	*	303	545	*	132	202
17	NAGALAND	883	1144	1287	210	303	341	56	111	149
18	ORISSA	27728	35893	40033	4193	7958	9405	1665	2443	4895
19	PUNJAB	7258	12383	12400	1060	1498	1421	1323	2169	2759
20	RAJASTHAN	19612	22474	30268	2035	5200	9406	1027	2482	4053
21	SIKKIM	+	321	510	+	94	122	+	37	75
22	TAMIL NADU	26076	27705	29979	5894	5679	5624	2634	3369	5147
23	TRIPURA	1384	1643	2097	220	294	425	89	196	456
24	UTTAR PRADESH	62127	70606	77995	8787	13555	17616	3415	5178	6053
25	WEST BENGAL	35788	45875	50389	2959	3153	3152	4199	5047	6491
26	A & N ISLANDS	127	175	185	20	34	42	9	25	66
27	CHANDIGARH	37	41	54	16	30	27	21	41	77
28	DADRA & NAGAR HAVELI	126	130	120	24	24	41	4	4	11
29	DAMAN & DIU	**	**	46	**	**	20	**	**	19
30	DELHI	1355	1726	1911	458	326	485	501	704	1130
31	LAKSHADWEEP	19	17	19	8	4	4	5	8	0
32	PONDICHEERY	259	279	341	81	97	107	46	77	105
INDIA		408378	494503	560935	90621	118555	151456	36738	51006	78688

* In case of Mizoram these are shown against Assam for 1971

** Included in Goa

+ Sikkim State was not part of India during 1970-71

ENROLMENT IN PRIMARY CLASSES (I-V)

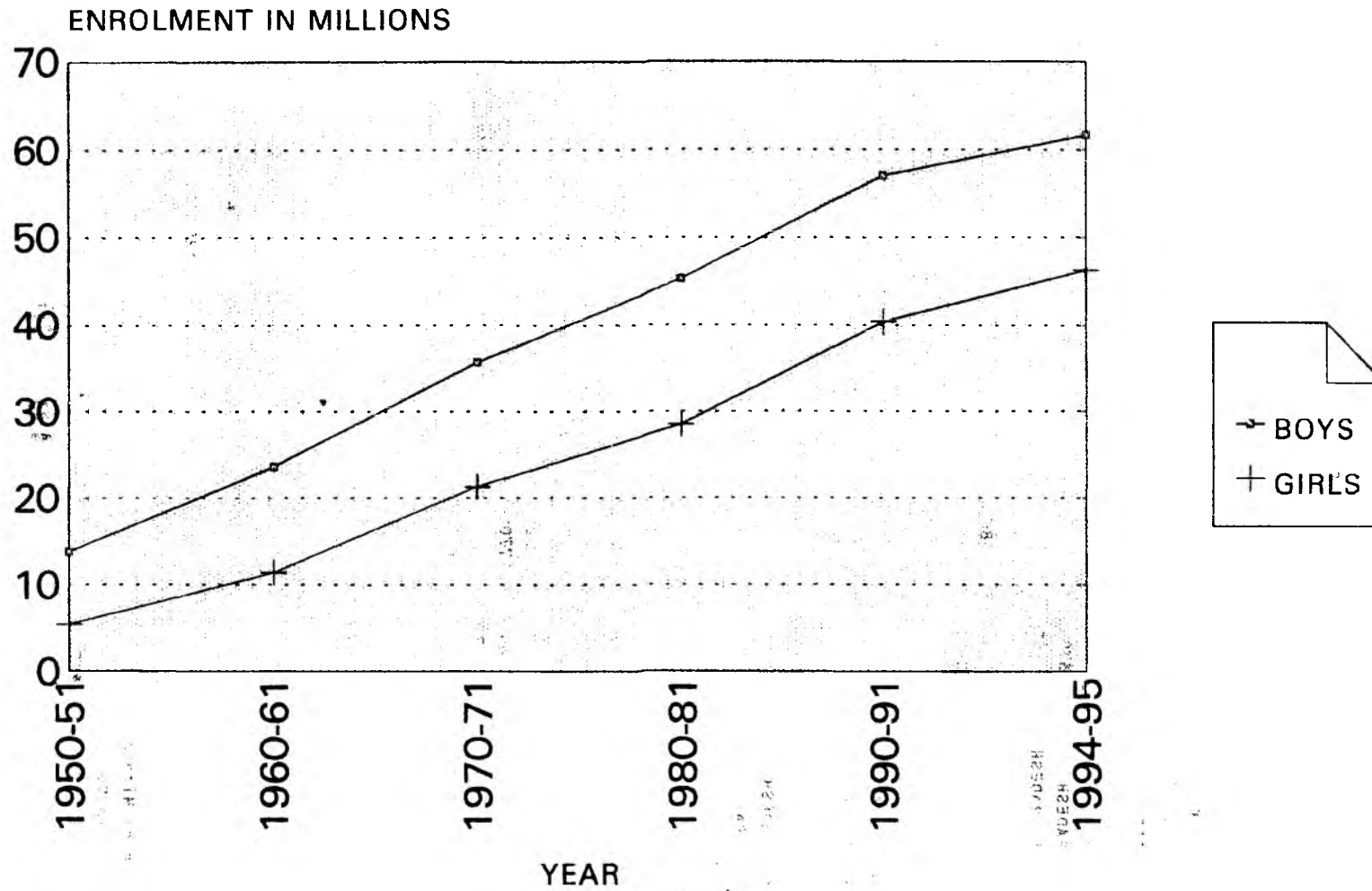

TABLE NO. 3.3

Statewise and Sexwise Growth of school enrolment in India
during 1950-51 to 1994-95

S.no.	Year	Primary Classes(I to V)			Middle Classes(VI-VIII)			High/Hr. Sec. Classes(IX-X)		
		Boys	Girls	Total	Boys	Girls	Total	Boys	Girls	Total
1	2	3	4	5	6	7	8	9	10	11
1	1950-51	13769855	5384602	19154457	2585741	534217	3119958	1252470	188784	144125
2	1960-61	23592727	11401102	34993829	5074345	1630465	6704810	2721102	624095	334519
3	1961-62	25983713	13118621	39102334	5616096	1865802	7481898	2971216	708397	367961
4	1962-63	27636983	14234585	41871568	6109238	2111545	8220783	3274638	830215	410485
5	1963-64	29120739	15428922	44549661	6684908	2356934	9041842	3545114	962300	450741
6	1964-65	31052198	17166109	48218307	7179452	2614907	9794359	3960756	1139144	509990
7	1965-66	32178011	18293211	50471222	7686032	2846272	10532304	4360761	1304978	566573
8	1966-67	33159671	19104175	52263846	8096914	3098974	11195888	4734186	1440264	617445
9	1967-68	33827382	19752501	53579883	8633060	3351440	11984500	4997669	1567405	656507
10	1968-69	34156879	20211838	54368717	8988717	3547836	12536553	5291571	1709804	700137
11	1969-70	34769097	20715889	55484986	9274554	3704198	12978752	5452684	1814163	726684
12	1970-71	35739221	21306220	57045441	9425697	3889473	13315170	5670112	1930431	760054
13	1971-72	36784828	22033816	58818644	9641134	4042531	13683665	5963796	2085504	804930
14	1972-73	38821604	23579025	62400629	9954384	4302691	14257075	6168694	2173192	834188
15	1973-74	39566466	24316413	63882879	10241834	4602987	14844821	6461470	2370483	883195
16	1974-75	40266540	24589098	64855638	10582259	4784120	15366379	6450434	2444667	889510
17	1975-76	40649037	25010985	65660022	10990007	5033785	16023792	6483906	2444828	892873
18	1976-77	42689910	26370820	69060730	11370473	5316309	16686782	6648947	2530238	917918
19	1977-78	41899252	25461736	67360988	11749283	5554691	17303974	6815705	2654190	946989
20	1978-79	42572616	26387954	68960570	12247112	5930619	18177731	7116641	2841374	995801
21	1979-80	44218753	27339336	71558089	13031477	6247425	19278902	7658159	3111425	1076958
22	1980-81	45286131	28488056	73774187	13933965	6790399	20724364	8391493	3479668	1187116
23	1981-82	46711178	29394730	76105908	14694510	7249678	21944188	8894024	3645677	1253970
24	1982-83	48571935	30935010	79506945	15663172	7967913	23631085	9770784	3977534	1374831
25	1983-84	50359270	32230920	82590190	16642612	8551897	25194509	10185747	4301049	1448679
26	1984-85	51921906	33733885	85655791	17216351	8999218	26215569	10807155	4669983	1547713
27	1985-86	52246774	35193740	87440514	17736098	9573757	27309855	11456807	5040718	1649752
28	1986-87	51683149	35446072	87129221	17870201	9620653	27490854	11433546	5218956	1665250
29	1987-88	53508121	36951776	90459897	18878240	10408708	29286948	10843090	4994190	1583728
30	1988-89	53835980	37435181	91271161	19267746	10682241	29949987	10943066	5311894	1625496
31	1989-90	54271681	38079377	92351058	19822671	11066150	30888821	11682734	5683443	1736617
32	1990-91	56954944	40420356	97375300	21487106	12538881	34025987	12780203	6277196	1905739
33	1991-92(P)	59217993	42359096	10577089	21448617	12997146	34445763	14183919	7043982	2122790
34	1992-93(P)	60454320	44915896	105370216	23693267	15015314	38708581	15010741	7699407	2271014
35	1993-94(P)	61804309	46396230	108200539	24213399	15701103	39914502	15273043	8074601	2334764
36	1994-95(P)	61705842	46275515	107981357	23967809	15317750	39285559	15742459	8395376	2413783

(P) Figures are provisional

ENROLMENT IN HIGH/Hr.SEC. CLASSES (IX-XII)

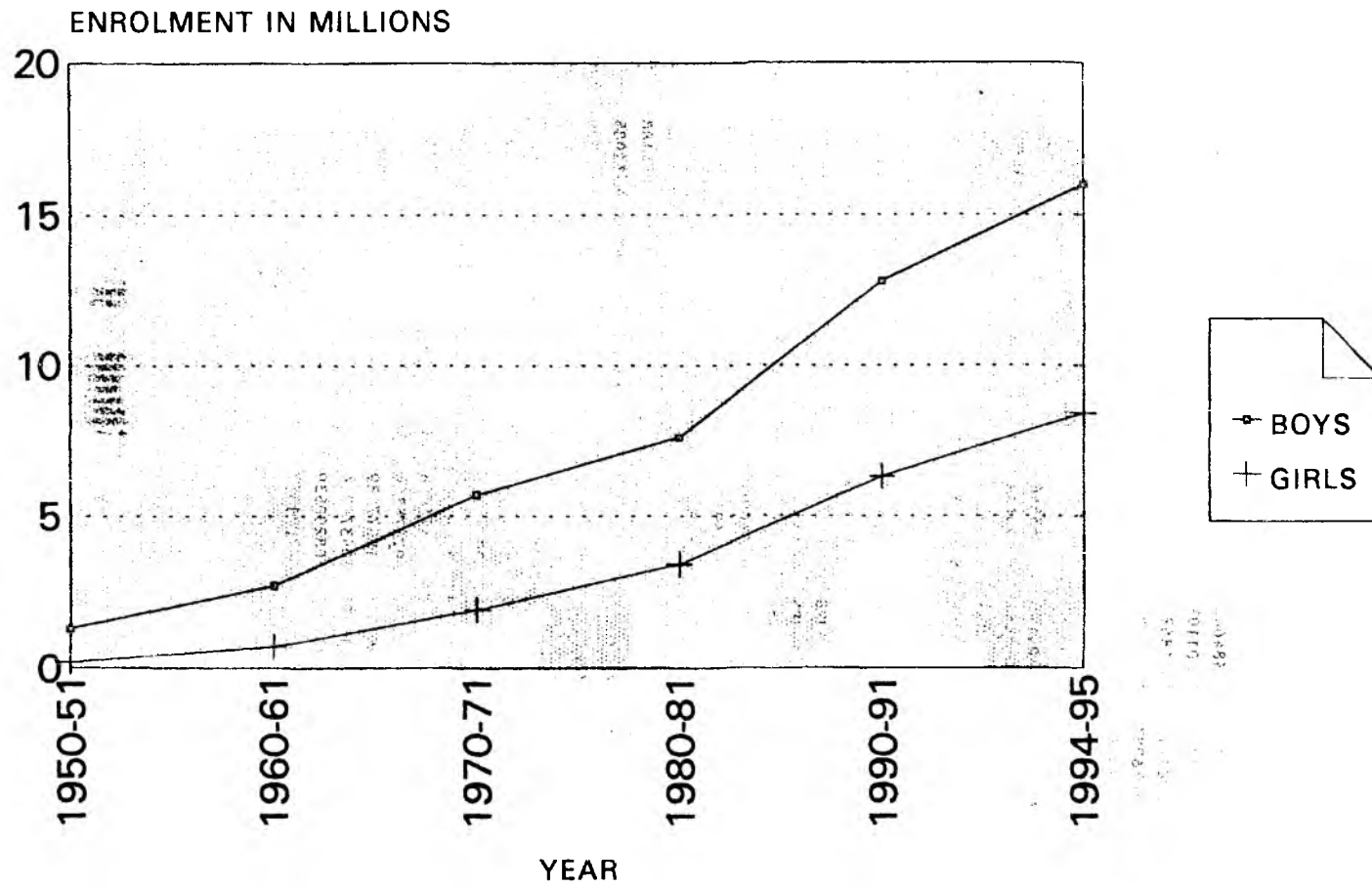

TABLE NO - 3.4(a)

Enrolment by Stages and Sex (School Level) for General in States
and Union Territories 1980-81

Sno.	State/Union Territories	Primary Schools (I to V)			Middle Schools (VI to VIII)			High/Hr Secondary Schools (IX to XII)		
		Boys	Girls	Total	Boys	Girls	Total	Boys	Girls	Total
1	2	3	4	5	6	7	8	9	10	11
1	ANDHRA PRADESH	3181634	2235706	5417340	805783	411690	1217473	369138	157755	526893
2	ASSAM	1166278	861368	2027646	356481	221675	578156	149121	86631	235752
3	BIHAR	4710467	1986715	6697182	1045886	283271	1329157	400303	74383	474686
4	GUJARAT	2554562	1761952	4316514	716195	418845	1135040	445884	235088	680972
5	HARYANA	823467	423410	1246877	352080	126177	478257	135828	41773	177601
6	HIMACHAL PRADESH	309637	233623	543260	136943	63414	200357	46590	16502	63092
7	JAMMU & KASHMIR	343234	194567	537801	114718	52493	167211	57418	26240	83658
8	KARNATAKA	2393040	1864324	4257364	678832	336123	1014955	353660	148498	502158
9	KERALA	1655575	1556386	3211961	834025	759266	1593291	490558	4001718	891276
10	MADHYA PRADESH	3301199	1600556	4901755	956129	318257	1274386	435051	129982	565033
11	MAHARASHTRA	4740873	3571342	8312215	1456592	832494	2289086	875758	410234	1276992
12	MANIPUR	117041	93821	210862	32053	21244	53297	12256	10205	27461
13	MEGHALAYA	58574	50983	109557	16143	14108	30251	7141	6226	13367
14	NAGALAND	49982	38280	88262	12840	9001	21841	4477	2260	6737
15	ORISSA	1667186	1083171	2750357	395295	190123	585418	231679	87794	319473
16	PUNJAB	1138914	931690	2070604	427243	273266	700509	179019	108654	287673
17	RAJASTHAN	2153508	696108	2849616	620137	146591	766728	346215	71053	417268
18	SIKKIM	25382	17177	42559	5162	2737	7899	1534	668	2202
19	TAMIL NADU	3480342	2865887	6346229	1148166	693866	1842032	576856	305460	882316
20	TRIPURA	168273	125593	293866	38405	26792	65197	23700	14474	38174
21	UTTAR PRADESH	6800535	2909257	9709792	2401577	650668	3052245	1556474	296985	1853459
22	WEST BENGAL	3851957	2891483	6743440	1108267	739109	1847376	701727	442657	1144384
23	A & N ISLANDS	14971	12636	27607	5086	3456	8542	2588	1787	4375
24	ARUNACHAL PRADESH	39775	20129	59904	6242	2645	8887	3080	921	4001
25	CHANDIGARH	16259	12953	29212	8890	6337	15227	3991	2909	6900
26	DADRA & NAGAR HAVELI	8485	5388	13873	1324	637	1961	479	259	738
27	DELHI	358335	310440	668775	187125	136475	323600	145267	107877	253144
28	GOA, DAMAN & DIU	84031	71609	155640	36341	28166	64507	17129	12790	29919
29	LAKSHADWEEP	4050	3352	7402	1581	915	2496	644	327	971
30	MIZORAM	26093	23137	49230	9298	7825	17123	3947	3023	6970
31	PONDICHEERY	42472	35013	77485	19126	12733	31859	10625	5659	16284
INDIA		45286131	28488056	73774187	13933965	6790399	20724364	7593137	3200792	10793929

ENROLMENT IN MIDDLE CLASSES (VI-VIII)

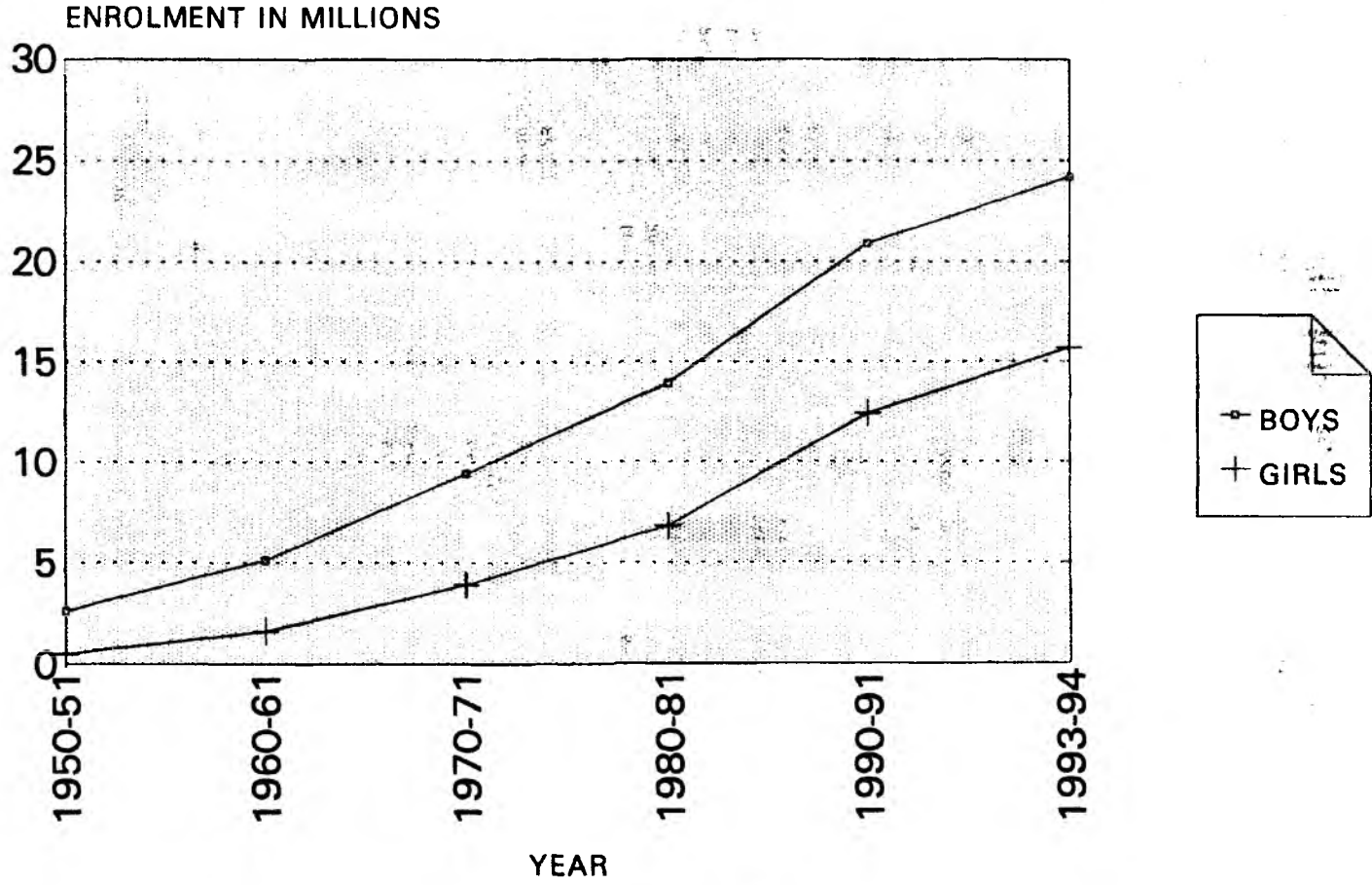

TABLE NO. 3.4(b)

Enrolment by stages and Sex (School Level) for General Education in States and Union Territories - 1990-91

Sno.	State/Union Territories	Primary Classes (I to V)			Middle Classes(VI to VIII)			High School Classes(IX -XII)		
		Boys	Girls	Total	Boys	Girls	Total	Boys	Girls	Total
1	2	3	4	5	6	7	8	9	10	11
1	ANDHRA PRADESH	4373762	3281840	7655602	1337694	796098	2133792	879863	411347	1291210
2	ARUNACHAL PRADESH	65043	47154	112197	15956	10133	26089	10688	5008	15696
3	ASSAM	1790432	1384799	3175231	576039	392397	968436	309898	194803	504701
4	BIHAR	5731970	2958422	8690392	1529164	570905	2100069	723845	194705	918550
5	GOA	71464	64366	135830	43483	37456	80939	32234	26811	59045
6	GUJARAT	3308176	2504056	5812232	1056831	660964	1717795	687863	423920	1111783
7	HARYANA	988240	765261	1753501	458477	267948	726425	270041	127411	397452
8	HIMACHAL PRADESH	346201	310714	656915	188569	142620	331189	134644	79700	214344
9	JAMMU & KASHMIR	457315	304603	761918	194323	112644	306967	110461	54431	164892
10	KARNATAKA	3124131	2612817	5736948	1034469	707479	1741948	734908	436251	1171159
11	KERALA	1626547	1540355	3166902	957983	907100	1865083	466752	473286	940038
12	MADHYA PRADESH	4797546	3372106	8169652	1682037	748369	2430406	920623	306588	1227211
13	MAHARASHTRA	5522632	4693817	10216449	2219992	1559499	3779491	1363993	784710	2148703
14	MANIPUR	142965	121054	264019	41780	35878	77658	30117	21057	51174
15	MEGHALAYA	76886	69690	146576	24038	24292	48330	10342	9597	19939
16	MIZORAM	63183	57117	120300	19568	19059	38627	8541	8138	16679
17	NAGALAND	78810	66600	145410	27979	25138	53117	11448	9466	20914
18	ORISSA	2376276	1643968	4020244	700191	420426	1120617	387593	177643	565236
19	PUNJAB	1115253	953958	2069211	535101	400158	935259	363231	253205	616436
20	RAJASTHAN	3169195	1415137	4584332	1076284	323517	1399801	692902	178886	871788
21	SIKKIM	38873	33625	72498	7776	7038	14814	5124	3588	8712
22	TAMIL NADU	4182459	3581414	7763873	1814266	1344281	3158547	988149	648138	1636287
23	TRIPURA	213802	176443	390245	65330	50675	116005	40018	26286	66304
24	UTTAR PRADESH	8036323	4134971	12171294	3154378	1141141	4295519	2313061	642012	2955073
25	WEST BENGAL	4657142	3770185	8427327	2367098	1555836	3922934	1017556	552019	1569575
26	A & N ISLANDS	21101	18829	39930	9886	8022	17908	6631	5583	12214
27	CHANDIGARH	26382	23248	49630	13584	12362	25946	15849	13802	29651
28	DADRA & NAGAR HAVELI	9821	6791	16612	2820	1598	4418	1526	905	2431
29	DAMAN & DIU	6620	6042	12662	3819	3147	6966	2407	1540	3947
30	DELHI	476463	446752	923215	295781	226055	521836	223675	193216	416891
31	LAKSHADWEEP	4537	3986	8523	1859	1348	3207	1050	712	1762
32	PONDICHERRY	55394	50236	105630	30551	25298	55849	15170	12432	27602
INDIA		56954944	40420356	97375300	21487106	12538881	34025987	12780203	6277196	19057399

TABLE NO. 3.5
Enrolment by classes and sex in States and Union Territories 1980-81 and 1990-91

Sno.	State/Union Territories	Class I					
		1980 - 81			1990 - 91		
		Boys	Girls	Total	Boys	Girls	Total
1	2	3	4	5	6	7	8
1	ANDHRA PRADESH	1079450	794318	1873768	1342821	1038371	2381192
2	ARUNACHAL PRADESH	16614	8534	25148	22683	16886	39569
3	ASSAM	470359	357603	827962	618570	502190	1120760
4	BIHAR	1738952	784757	2523709	1979781	1076021	3055802
5	GOA	20279	17766	38045	15154	14220	29374
6	GUJARAT	715659	534563	1250222	913412	742690	1656102
7	HARYANA	212069	123756	335825	235989	193855	429844
8	HIMACHAL PRADESH	82210	65367	147577	81189	74415	155604
9	JAMMU & KASHMIR	104559	66630	171189	118658	85718	204376
10	KARNATAKA	700607	592751	1293358	787228	692434	1479662
11	KERALA	324409	310052	634461	310253	297947	608200
12	MADHYA PRADESH	939307	509796	1449103	1140568	876486	2017054
13	MAHARASHTRA	1355859	1131678	2487537	1337659	1181136	2518795
14	MANIPUR	53525	46772	100297	64670	55920	120590
15	MEGHALAYA	17551	14792	32343	20023	17815	37838
16	MIZORAM	6423	5882	12305	24331	22023	46354
17	NAGALAND	15405	10959	26364	20948	17350	38298
18	ORISSA	469814	336866	806680	683514	455583	1139097
19	PUNJAB	325760	285433	611193	238264	207952	446216
20	RAJASTHAN	1202008	414504	1616512	1062573	519411	1581984
21	SIKKIM	9122	6730	15852	13447	11386	24833
22	TAMIL NADU	813281	683073	1496354	985837	858015	1843852
23	TRIPURA	68578	53322	121900	67754	57576	125330
24	UTTAR PRADESH	1800448	849550	2649998	1968620	1052617	3021237
25	WEST BENGAL	1334351	976796	2311147	1401272	1263923	2665195
26	A & N ISLANDS	3946	3554	7500	4744	4343	9087
27	CHANDIGARH	4221	3508	7729	5947	5050	10997
28	DADRA & NAGAR HAVELI	1985	1530	3515	2433	1910	4343
29	DAMAN & DIU	0	0	0	1433	1226	2659
30	DELHI	80799	76712	157511	113734	110462	224196
31	LAKSHADWEEP	852	762	1614	907	786	1693
32	PONDICHEERY	8502	7359	15861	11354	10286	21640
INDIA		13976904	9075675	23052579	15595770	11466003	27061773

0 It is included in GOA

TABLE NO. 3.5

Enrolment by classes and Sex in States and Union Territories 1980-81 and 1990-91(Contd.)

Sno.	State/Union Territories	Class II					
		1980 - 81			1990 - 91		
		Boys	Girls	Total	Boys	Girls	Total
1	2	9	10	11	12	13	14
1	ANDHRA PRADESH	704435	506356	1210791	991455	783373	1774828
2	ARUNACHAL PRADESH	8835	4485	13320	14906	10691	25597
3	ASSAM	210336	160656	370992	360565	281042	641607
4	BIHAR	996628	428101	1424729	1213835	635841	1849676
5	GOA	20241	17588	37829	12477	11625	24102
6	GUJARAT	555650	388201	943851	695809	543612	1239421
7	HARYANA	178872	96343	275215	207033	165023	372056
8	HIMACHAL PRADESH	62749	49101	111850	72048	66333	138381
9	JAMMU & KASHMIR	75098	41688	116786	98559	62011	160570
10	KARNATAKA	559996	441276	1001272	695821	597827	1293648
11	KERALA	341757	323193	664950	319710	302677	622387
12	MADHYA PRADESH	716048	366554	1082602	1001641	749627	1751268
13	MAHARASHTRA	1071106	833764	1904870	1168539	1030158	2198697
14	MANIPUR	20048	16326	36374	23192	19478	42670
15	MEGHALAYA	12144	11620	23764	14432	13627	28059
16	MIZORAM	5343	4913	10256	11408	9897	21305
17	NAGALAND	12228	9249	21477	18456	15280	33736
18	ORISSA	363081	240897	603978	557310	397439	954749
19	PUNJAB	247713	201937	449650	246737	210563	457300
20	RAJASTHAN	-	-	-	708382	346275	1054657
21	SIKKIM	5265	3665	8930	7693	6679	14372
22	TAMIL NADU	700157	595113	1295270	866035	749165	1615200
23	TRIPURA	33226	24689	57915	45049	36966	82015
24	UTTAR PRADESH	1552334	692637	2244971	1695829	928794	2624623
25	WEST BENGAL	815149	595724	1410873	960618	776200	1736818
26	A & N ISLANDS	3037	2654	5691	4227	3867	8094
27	CHANDIGARH	3221	2640	5861	5207	4637	9844
28	DADRA & NAGAR HAVELI	1789	1305	3094	2156	1661	3817
29	DAMAN & DIU	0	0	0	1230	1117	2347
30	DELHI	74218	67094	141312	99832	95962	195794
31	LAKSHADWEEP	844	762	1606	932	790	1722
32	PONDICHEERY	7672	6685	14357	10477	9581	20058
INDIA		9359130	6135216	15494346	12131600	8867818	20999418

0 Included in Goa

TABLE NO. 3.5

Enrolment by classes and Sex in States and Union Territories 1980-81 and 1990-91(Contd.)

Sno.	State/Union Territories	Class III					
		1980 - 81			1990 - 91		
		Boys	Girls	Total	Boys	Girls	Total
1	2	15	16	17	18	19	20
1	ANDHRA PRADESH	557804	384461	942265	774682	590195	1364877
2	ARUNACHAL PRADESH	6189	3204	9393	10983	5085	19068
3	ASSAM	180110	134022	314132	297306	238913	536219
4	BIHAR	808702	338386	147088	993639	498501	1492140
5	GOA	15969	13530	29499	12689	11805	24494
6	GUJARAT	547258	372167	919425	645056	489352	1134408
7	HARYANA	160741	80341	241082	196504	156717	353221
8	HIMACHAL PRADESH	57124	43149	100273	69718	61964	131682
9	JAMMU & KASHMIR	62079	34295	96374	119217	66711	185928
10	KARNATAKA	451811	361255	813066	644796	543023	1187819
11	KERALA	333968	314866	648834	321999	304146	626145
12	MADHYA PRADESH	706766	329003	1035769	1049609	743481	1793090
13	MAHARASHTRA	919954	670258	1590212	1142566	987190	2129756
14	MANIPUR	16891	12198	29089	19993	17197	37190
15	MEGHALAYA	11041	8976	20017	14207	12841	27048
16	MIZORAM	4923	4453	9376	10109	9329	19438
17	NAGALAND	9011	7359	16370	15135	12941	28076
18	ORISSA	342798	220750	563548	458392	324959	783351
19	PUNJAB	214395	171422	385817	235428	199250	434678
20	RAJASTHAN	355826	106496	462322	496289	211372	707661
21	SIKKIM	4476	2955	7431	7015	6040	13055
22	TAMIL NADU	668227	553387	1221614	784140	676620	1460760
23	TRIPURA	28682	20815	49497	42556	35395	77951
24	UTTAR PRADESH	1351249	574702	1925951	1696527	895233	2591760
25	WEST BENGAL	630647	530379	1161026	804923	676756	1481679
26	A & N ISLANDS	3070	2556	5626	3951	3638	7589
27	CHANDIGARH	3010	2390	5400	5288	4740	10028
28	DADRA & NAGAR HAVELI	2496	1513	4009	2129	1405	3534
29	DAMAN & DIU	a	a	a	1260	1115	2375
30	DELHI	73214	62397	135611	90972	86074	177046
31	LAKSHADWEEP	882	684	1566	842	850	1692
32	PONDICHERY	9086	7889	16975	11826	10479	22305
INDIA		8538399	5370254	13908653	10979746	7886317	18866063

a It is included in Goa

LIBRARY & DOCUMENTATION CENTRE
 National Institute of Educational
 Planning and Administration,
 17-B, Sri Aurobindo Marg,
 New Delhi-110016
 DOC, No. D-9470
 Date 09-04-97

TABLE NO. 3.5

Enrolment by classes and Sex in States and Union Territories 1980-81 and 1990-91(Contd.)

Sno.	State/Union Territories	1980 - 81			Class IV			1990 - 91		
		Boys	Girls	Total	Boys	Girls	Total	Boys	Girls	Total
1	2	21	22	23	24	25	26	27	28	29
1	ANDHRA PRADESH	456300	304301	760601	657763	459349	1117112			
2	ARUNACHAL PRADESH	4831	2329	7160	9060	6260	15320			
3	ASSAM	146610	106610	253220	242969	185257	428226			
4	BIHAR	636148	253311	889459	821117	414865	1235982			
5	GOA	13180	11195	24375	14388	12815	27203			
6	GUJARAT	406918	263404	670322	563331	392806	956137			
7	HARYANA	139415	64656	204171	1785049	134531	313040			
8	HIMACHAL PRADESH	54690	39247	93937	65124	57514	122638			
9	JAMMU & KASHMIR	54679	28418	83097	68454	44594	113048			
10	KARNATAKA	375208	278600	653808	562333	450565	1012898			
11	KERALA	339345	318702	657047	331727	311823	643550			
12	MADHYA PRADESH	513195	220681	733876	878798	563854	1442652			
13	MAHARASHTRA	726375	509029	1235404	955518	792187	1747705			
14	MANIPUR	13985	9562	23547	18457	14787	33244			
15	MEGHALAYA	9517	8403	17920	14131	12716	26847			
16	MIZORAM	4903	4072	8975	8708	7881	16589			
17	NAGALAND	7233	5815	13048	13014	11238	24252			
18	ORISSA	272740	165942	438682	367304	251939	619243			
19	PUNJAB	189457	149065	338522	214180	181831	396011			
20	RAJASTHAN	329750	96717	426467	477053	182692	659745			
21	SIKKIM	3573	2222	5795	5500	4645	10145			
22	TAMIL NADU	721520	583423	1304943	774151	665708	1439859			
23	TRIPURA	21110	15009	36119	33342	26199	59541			
24	UTTAR PRADESH	1149270	452518	1601788	1455706	705514	2161220			
25	WEST BENGAL	569511	425835	995346	723740	590082	1313822			
26	A & N ISLANDS	2665	2106	4771	4173	3600	7773			
27	CHANDIGARH	2940	2410	5350	5058	4484	9542			
28	DADRA & NAGAR HAVELI	1521	712	2233	1741	1059	2800			
29	DAMAN & DIU	a	a	a	1069	1323	2392			
30	DELHI	69222	55469	124691	88409	81443	169852			
31	LAKSHADWEEP	807	623	1430	997	845	1842			
32	PONDICHEERY	8877	7016	15893	11225	10276	21501			
	INDIA	7245495	4387402	11632897	9567049	6584682	16151731			

1 Included in Goa

TABLE NO. 3.5

Enrolment by classes and Sex in States and Union Territories 1980-81 and 1990-91(Contd.)

		Class V					
		1980 - 81			1990 - 91		
Sno.	State/Union Territories	Boys	Girls	Total	Boys	Girls	Total
1	2	27	28	29	30	31	32
1	ANDHRA PRADESH	383645	246270	629915	607041	410552	1017593
2	ARUNACHAL PRADESH	3306	1577	4883	7411	5232	12643
3	ASSAM	158863	102477	261340	271622	177397	448419
4	BIHAR	530073	182160	712233	723598	333194	1056792
5	GOA	14362	11530	25892	16756	13901	30657
6	GUJARAT	329077	203617	532694	490568	335596	826164
7	HARYANA	132370	58314	190684	170205	115135	285340
8	HIMACHAL PRADESH	52864	36759	89623	58122	50488	108610
9	JAMMU & KASHMIR	46819	23536	70355	52427	45569	97996
10	KARNATAKA	305418	190442	495860	433953	328968	762921
11	KERALA	316096	289573	605669	342858	323762	666620
12	MADHYA PRADESH	425883	174522	600405	726930	438658	1165588
13	MAHARASHTRA	667669	426613	1094282	918350	703146	1621496
14	MANIPUR	12592	8963	21555	16653	13672	30325
15	MEGHALAYA	8321	7192	15513	14093	12691	26784
16	MIZORAM	4501	3817	8318	8627	7987	16614
17	NAGALAND	6105	4898	11003	11257	9791	21048
18	ORISSA	218753	118716	337469	309756	214048	523804
19	PUNJAB	161589	123833	285422	180644	154362	335006
20	RAJASTHAN	265924	78391	344315	424898	155387	580285
21	SIKKIM	2946	1605	4551	5218	4875	10093
22	TAMIL NADU	577157	450891	1028048	772296	631906	1404202
23	TRIPURA	16677	11758	28435	25101	20307	45408
24	UTTAR PRADESH	947234	339850	1287084	1219641	552813	1772454
25	WEST BENGAL	502299	362753	865052	766589	463224	1229813
26	A & N ISLANDS	2253	1766	4019	4006	3381	7387
27	CHANDIGARH	2867	2005	4872	4882	4337	9219
28	DADRA & NAGAR HAVELI	694	328	1022	1362	756	2118
29	DAMAN & DIU	0	0	0	1628	1261	2889
30	DELHI	60882	48768	109650	83516	72811	156327
31	LAKSHADWEEP	665	521	1186	859	715	1574
32	PONDICHEERY	8335	6064	14399	10512	9614	20126
INDIA		6166203	3519509	9685712	8680779	5615536	14296315

0 Included in Goa

TABLE NO. 3.5

Enrolment by classes and Sex in States and Union Territories 1980-81 and 1990-91(Contd.)

Sno.	State/Union Territories	Class VI					
		1980 - 81			1990 - 91		
		Boys	Girls	Total	Boys	Girls	Total
1	2	33	34	35	36	37	38
1	ANDHRA PRADESH	307413	163885	471298	514386	322556	836942
2	ARUNACHAL PRADESH	2669	1174	3843	6326	4205	10531
3	ASSAM	148053	95979	244032	272984	152251	380235
4	BIHAR	422362	127615	549977	581952	229095	811047
5	GOA	12757	10071	23828	14931	12594	27525
6	GUJARAT	267148	162914	430062	392576	258445	651021
7	HARYANA	123552	49846	173398	165762	103784	269546
8	HIMACHAL PRADESH	51345	26295	77640	67809	52908	120717
9	JAMMU & KASHMIR	43459	20453	63912	74252	48814	123066
10	KARNATAKA	228107	152852	380959	382653	276107	658760
11	KERALA	289915	265012	554927	331864	314367	646231
12	MADHYA PRADESH	376687	129400	506087	636577	302698	939275
13	MAHARASHTRA	556009	342002	898011	798990	598145	1397135
14	MANIPUR	11562	8253	19815	14656	13234	27890
15	MEGHALAYA	6825	6051	12876	11044	10683	21727
16	MIZORAM	3719	3149	6868	7403	6964	14367
17	NAGALAND	5627	4313	9940	10362	9272	19634
18	ORISSA	140088	74585	214673	263777	190497	454274
19	PUNJAB	155623	102539	258162	202403	149629	352032
20	RAJASTHAN	251221	60295	311516	433207	132352	565559
21	SIKKIM	2217	1168	3385	3214	3024	6238
22	TAMIL NADU	475460	288852	764312	700560	510903	1211463
23	TRIPURA	15200	10446	25646	25515	19084	45499
24	UTTAR PRADESH	911115	253839	1164954	1173493	429986	1603479
25	WEST BENGAL	450950	274877	725827	894428	596286	1490714
26	A & N ISLANDS	1938	1314	3252	3661	2907	6568
27	CHANDIGARH	3289	2308	5597	4785	4351	9136
28	DADRA & NAGAR HAVELI	514	264	778	1086	627	1713
29	DAMAN & DIU	0	0	0	1259	1189	2378
30	DELHI	75025	54484	129509	104840	82640	187480
31	LAKSHADWEEP	583	398	981	736	504	1240
32	PONDICHEERY	7358	5326	12684	10945	9630	20575
	INDIA	5347790	2699959	8047749	8063436	4850561	12913997

It is included in Goa

TABLE NO. 3.5

Enrolment by classes and Sex in States and Union Territories 1980-81 and 1990-91(Contd.)

Sno.	State/Union Territories	Class VII					
		1980 - 81			1990 - 91		
		Boys	Girls	Total	Boys	Girls	Total
1	2	39	40	41	42	43	44
1	ANDHRA PRADESH	294198	149298	443496	449273	275221	724494
2	ARUNACHAL PRADESH	1983	833	2816	5397	3353	8750
3	ASSAM	119637	72537	192174	193247	127619	320866
4	BIHAR	342393	94251	436644	504721	192489	697210
5	GOA	11896	9194	21090	13558	11968	25526
6	GUJARAT	225925	136104	362029	325147	201105	526252
7	HARYANA	120030	40876	160906	149290	85474	234764
8	HIMACHAL PRADESH	42908	19357	62265	58795	44636	103431
9	JAMMU & KASHMIR	37160	16889	54049	63273	44321	107594
10	KARNATAKA	216181	130113	346294	328818	229701	558519
11	KERALA	282207	258561	540768	325383	309846	635229
12	MADHYA PRADESH	286737	97671	384408	503364	239047	769411
13	MAHARASHTRA	483419	281320	764739	723900	521791	1245691
14	MANIPUR	10628	6959	17587	14108	11592	25700
15	MEGHALAYA	5070	4280	9250	6891	7404	14295
16	MIZORAM	2971	2477	5448	6672	6485	13157
17	NAGALAND	4266	2872	7138	9057	8423	17480
18	ORISSA	114340	58007	172347	224149	129620	353769
19	PUNJAB	135933	86827	222760	176713	133883	310596
20	RAJASTHAN	198939	40984	239923	346836	103942	450778
21	SIKKIM	1525	815	2340	2183	1941	4124
22	TAMIL NADU	367170	221942	589112	572122	435079	1007201
23	TRIPURA	12695	9084	21779	21090	16474	37564
24	UTTAR PRADESH	797910	210895	1008805	1015621	372536	1388157
25	WEST BENGAL	380648	255400	636048	813617	520181	1333798
26	A & N ISLANDS	1650	1158	2808	3188	2682	5870
27	CHANDIGARH	2910	2221	5131	4562	4086	8648
28	DADRA & NAGAR HAVELI	413	193	606	904	478	1382
29	DAMAN & DIU	0	0	0	1176	1058	2234
30	DELHI	59707	44263	103970	99293	75175	174468
31	LAKSHADWEEP	552	262	814	565	426	991
32	PONDICHERY	6189	4034	10223	9710	8265	17975
	INDIA	4568190	2265666	6833856	6999623	4126301	11125924

a Included in Goa

TABLE NO. 3.5

Enrolment by classes and Sex in States and Union Territories 1980-81 and 1990-91(Contd.)

		Class VIII					
		1980 - 81			1990 - 91		
Sno.	State/Union Territories	Boys	Girls	Total	Boys	Girls	Total
1	2	45	46	47	48	49	50
1	ANDHRA PRADESH	204172	98517	302689	374035	198321	572356
2	ARUNACHAL PRADESH	1590	638	2228	4233	2575	6808
3	ASSAM	88791	53159	141950	154808	112527	267335
4	BIHAR	281131	61405	342536	442491	149321	591812
5	GOA	11688	8901	20589	14994	12894	27888
6	GUJARAT	223122	119827	342949	339108	201414	540522
7	HARYANA	108498	35455	143953	143425	78690	222115
8	HIMACHAL PRADESH	42690	17762	60452	61965	45076	107041
9	JAMMU & KASHMIR	34099	15151	49250	56798	19509	76307
10	KARNATAKA	234544	53158	287702	322998	201671	524669
11	KERALA	261903	235693	497596	300736	582887	583623
12	MADHYA PRADESH	292705	91186	383891	515096	206624	721720
13	MAHARASHTRA	417164	209172	626336	697102	439563	1136665
14	MAHIPPUR	9863	6032	15895	13016	11052	24068
15	MEGHALAYA	4248	3777	8025	6103	6205	12308
16	MIZORAM	2608	2199	4807	5493	5610	11103
17	NAGALAND	2947	1816	4763	8560	7443	16003
18	ORISSA	140867	57531	198398	212265	100309	312574
19	PUNJAB	135687	83900	219587	155985	116646	272631
20	RAJASTHAN	169977	39312	209289	296241	87223	383464
21	SIKKIM	1420	754	2174	2379	2073	4452
22	TAMIL NADU	305536	183072	488608	541584	398299	939883
23	TRIPURA	10510	7262	17772	18725	14217	32942
24	UTTAR PRADESH	692552	185935	878487	965264	338619	1303883
25	WEST BENGAL	276669	208832	485501	659053	439369	1098422
26	A & N ISLANDS	1498	984	2482	3037	2433	5470
27	CHANDIGARH	2691	1808	4499	4237	3925	8162
28	DADRA & NAGAR HAVELI	397	180	577	830	493	1323
29	DAMAN & DIU	a	a	a	1384	970	2354
30	DELHI	52393	37728	90121	91648	68240	159888
31	LAKSHADWEEP	446	255	701	558	418	976
32	PONDICHEERY	5579	3373	8952	9896	7403	17299
	INDIA	4017985	1824774	5842759	6424047	3562019	9986066

@ It is included in Goa

TABLE NO. 3.5

Enrolment by classes and Sex in States and Union Territories 1980-81 and 1990-91(Contd.)

Sno.	State/Union Territories	Class IX					
		1980 - 81			1990 - 91		
		Boys	Girls	Total	Boys	Girls	Total
1	2	51	52	53	54	55	56
1	ANDHRA PRADESH	197998	86785	284783	356088	173393	529481
2	ARUNACHAL PRADESH	1250	460	1710	3544	2034	5578
3	ASSAM	76538	51517	128055	137187	94818	232005
4	BIHAR	213991	41308	255299	369921	100122	470043
5	GOA	8023	6130	14153	14994	12894	27888
6	GUJARAT	177682	94671	272353	268758	162519	431277
7	HARYANA	65895	20333	86228	102623	54197	156820
8	HIMACHAL PRADESH	23316	8545	31861	51870	34314	86184
9	JAMMU & KASHMIR	28550	12154	40704	44648	24009	68657
10	KARNATAKA	159447	71500	230947	271513	169638	441151
11	KERALA	313330	226697	540027	266532	263001	529533
12	MADHYA PRADESH	185928	54177	240105	317722	106820	424542
13	MAHARASHTRA	352610	168323	520933	34419	379939	1014358
14	MANIPUR	8438	4749	13187	12843	9617	22460
15	MEGHALAYA	3994	3654	7648	5557	5358	10915
16	MIZORAM	2300	1949	4249	3649	3494	7143
17	NAGALAND	2636	1362	3998	6165	5610	11775
18	ORISSA	89907	34734	124641	183117	84988	268105
19	PUNJAB	81450	49127	130579	153079	110666	263725
20	RAJASTHAN	168458	33679	202137	288526	74471	362997
21	SIKKIM	643	327	970	2280	1874	4154
22	TAMIL NADU	262992	135735	398727	419601	258590	678191
23	TRIPURA	9526	6526	16052	17829	12776	30605
24	UTTAR PRADESH	513999	101433	615432	795654	211181	1006835
25	WEST BENGAL	263212	207134	470346	410381	202129	612510
26	A & N ISLANDS	1163	821	1984	2707	2307	5014
27	CHANDIGARH	2049	1560	3609	4052	3920	7972
28	DADRA & NAGAR HAVELI	201	114	315	830	493	1323
29	DAMAN & DIU	0	0	0	905	649	1554
30	DELHI	52534	37637	90171	91648	68240	159888
31	LAKSHADWEEP	373	205	578	476	337	813
32	PONDICHERY	4887	2751	7638	6608	5348	11956
	INDIA	3273320	1466097	4739417	5230956	2636587	7867543

0 Included in Goa

TABLE NO. 3.5

Enrolment by classes and Sex in States and Union Territories 1980-81 and 1990-91(Contd.)

Sno. State/Union Territories		Class X					
		1980 - 81			1990 - 91		
		Boys	Girls	Total	Boys	Girls	Total
1	2	57	58	59	60	61	62
1	ANDHRA PRADESH	170040	70557	240597	291672	137981	429653
2	ARUNACHAL PRADESH	896	238	1134	3510	1683	5193
3	ASSAM	60292	31486	91778	127947	78133	206080
4	BIHAR	185434	32717	218151	320375	81974	402349
5	GOA	4771	3603	8374	8940	7580	16520
6	GUJARAT	139461	76221	215682	222441	135693	358134
7	MARYANA	65576	19045	84621	88935	42798	131733
8	HIMACHAL PRADESH	19531	6706	26237	46475	28741	75216
9	JAMMU & KASHMIR	16497	7943	24440	34610	14502	49112
10	KARNATAKA	137590	57650	195240	226949	141022	367971
11	KERALA	176899	173909	350808	193364	205249	398613
12	MADHYA PRADESH	125528	40080	165608	306398	99993	406391
13	MAHARASHTRA	267200	122281	389481	493980	279218	773198
14	MANIPUR	8271	4982	13253	14030	10210	24240
15	MEGHALAYA	3147	2572	5719	4690	4238	8928
16	MIZORAM	1647	1074	2721	4595	4446	9041
17	NAGALAND	1841	898	2739	5248	3840	9088
18	ORISSA	71744	26204	97948	147222	70710	217932
19	PUNJAB	82008	51107	133115	141392	98159	239551
20	RAJASTHAN	116814	25195	142009	198321	53684	252005
21	SIKKIM	397	177	574	1452	1047	2499
22	TAMIL NADU	182031	92502	274533	288629	190915	479544
23	TRIPURA	7017	4233	11250	11659	8147	19806
24	UTTAR PRADESH	500891	85519	586410	779694	195293	974987
25	WEST BENGAL	210750	126214	336964	300687	200458	501145
26	A & N ISLANDS	684	463	1147	1712	1467	3179
27	CHANDIGARH	1582	1010	2592	3944	3493	7437
28	DADRA & NAGAR HAVELI	164	96	260	461	249	710
29	DAHAN & DIU	a	a	a	721	483	1204
30	DELHI	43892	30895	74787	66352	53605	119957
31	LAKSHADWEEP	271	122	393	225	153	378
32	PONDICHEERY	3390	1702	5092	4088	3458	7546
INDIA		2606256	1097401	3703657	4339772	2157670	6497442

a Included in Goa

CHAPTER -IV

SELECTED INDICATORS IN EDUCATION

TABLE NOs 4.1 TO 4.9

TABLE NO. 4.1

INDEX OF ENROLMENT GROWTH BY STAGES IN INDIA FROM 1960-61 TO 1994-95(SCHOOL LEVEL)(BASE YEAR 1961

S.NO.	YEAR	Primary (I-V)			MIDDLE (VI-VIII)			HIGH/HR SECONDARY (B)		
		BOYS	GIRLS	TOTAL	BOYS	GIRLS	TOTAL	BOYS	GIRLS	TOTAL
1	2	3	4	5	6	7	8	9	10	11
1	1960-61	100	100	100	100	100	100	100	100	100
2	1961-62	110	115	112	111	114	112	109	114	110
3	1962-63	117	125	120	120	130	123	120	133	123
4	1963-64	123	135	127	132	145	135	130	154	135
5	1964-65	132	151	138	141	160	146	146	183	152
6	1965-66	136	160	144	151	175	157	160	209	169
7	1966-67	141	168	149	160	190	167	174	231	185
8	1967-68	143	173	153	170	206	179	184	251	196
9	1968-69	145	177	155	177	218	187	194	274	209
10	1969-70	147	182	159	183	227	194	200	291	217
11	1970-71	151	187	163	186	239	199	208	309	227
12	1971-72	156	193	168	190	248	204	219	334	241
13	1972-73	165	207	178	196	264	213	227	348	249
14	1973-74	168	213	183	202	282	221	237	380	264
15	1974-75	171	216	185	209	293	229	237	392	266
16	1975-76	172	219	188	217	309	239	238	392	267
17	1976-77	181	231	197	224	326	249	244	405	274
18	1977-78	178	223	193	232	341	258	250	425	286
19	1978-79	180	231	197	241	364	271	262	455	298
20	1979-80	187	240	204	257	383	288	281	499	322
21	1980-81	192	250	211	275	416	309	308	558	355
22	1981-82	198	258	217	290	445	327	327	584	375
23	1982-83	206	271	227	309	459	352	359	637	411
24	1983-84	213	283	236	328	525	376	374	689	433
25	1984-85	220	296	245	339	552	391	397	748	463
26	1985-86	221	309	250	350	587	407	421	808	493
27	1986-87	219	311	249	352	590	410	420	836	498
28	1987-88	227	324	259	372	638	437	398	800	473
29	1988-89	228	328	261	380	655	447	402	851	486
30	1989-90	230	334	264	391	679	461	429	911	519
31	1990-91	241	355	278	423	769	507	470	1006	570
32	1991-92(P)	251	372	290	423	797	514	521	1129	635
33	1992-93(P)	256	394	301	467	921	577	552	1234	679
34	1993-94(P)	262	407	309	477	963	595	561	1294	698
35	1994-95(P)	262	406	309	472	939	586	579	1345	722

(P) Provisional

B Includes enrolment figures of Intermediate and Pre-university

TABLE NO. 4.2

ALL INDIA GROSS ENROLMENT RATIOS AT DIFFERENT LEVEL (SCHOOL EDUCATION)
1950-51 TO 1994-95

S.NO	YEAR	Primary (I-V) (6 - 11 YEARS)			MIDDLE (VI-VIII) (11 - 14 YEARS)			HIGH/HR SECONDARY (15 - 18 YEARS)		
		BOYS	GIRLS	TOTAL	BOYS	GIRLS	TOTAL	BOYS	GIRLS	TOTAL
1	2	3	4	5	6	7	8	9	10	11
1	1960-61	82.60	41.40	62.40	33.20	11.30	22.50	16.70	4.10	10.60
2	1970-71	95.50	60.50	78.60	46.30	19.90	33.40	26.80	9.80	18.50
3	1975-76	100.40	66.10	83.80	48.60	23.90	36.70	25.60	10.50	18.30
4	1980-81	95.80	64.10	80.50	54.30	28.60	41.90	23.10	11.10	17.30
5	1981-82	98.92	66.18	83.00	55.96	29.67	43.29	24.10	11.31	18.01
6	1982-83	102.96	69.65	86.81	58.31	31.75	45.48	25.12	11.60	18.64
7	1983-84	106.86	72.57	90.22	60.58	33.20	47.33	25.39	12.11	19.01
8	1984-85	110.28	75.95	93.62	61.32	34.05	48.10	31.66	14.73	23.51
9	1985-86	111.08	79.24	95.62	61.83	35.34	48.96	32.72	15.45	24.39
10	1986-87	109.99	79.81	95.33	61.01	34.66	48.19	30.84	15.55	23.97
11	1987-88	113.97	83.19	99.00	63.13	36.62	50.21	29.44	14.46	22.19
12	1988-89	109.21	80.27	95.14	61.37	35.76	48.89	28.38	15.33	22.07
13	1989-90	109.73	81.34	95.93	71.99	42.15	57.43	31.20	16.34	23.99
14	1990-91	113.95	85.47	100.10	76.56	46.98	62.14	33.89	10.27	19.28
15	1991-92(P)	116.61	88.09	102.74	74.19	47.40	61.15	38.07	20.04	29.32
16	1992-93(P)	118.10	92.70	105.70	80.58	53.80	67.50	40.10	21.77	31.20
17	1993-94(P)	115.30	92.90	104.50	79.35	55.20	67.70	40.62	22.69	31.90
18	1994-95(P)	114.80	92.60	104.00	79.00	55.00	67.20	41.50	23.31	32.64

(P) Provisional

N.A. Data for States not available

TABLE NO - 4.3(a)

GROSS ENROLMENT RATIOS AT DIFFERENT LEVELS - STATES/UTs., 1980-81

S.no.	State/UTs	PRIMARY CLASSES I - V (6 - 11)			MIDDLE CLASSES VI-VIII(11-14)			HIGHER SEC. CLASSES IX - XII (15 - 17)		
		Boys	Girls	Total	Boys	Girls	Total	Boys	Girls	Total
1	2	3	4	5	6	7	8	9	10	11
1	ANDHRA PRADESH	86.9	61.8	74.5	41.8	22.3	32.3	25.8	11.4	18.7
2	ASSAM	78.8	62.6	71.0	48.8	31.0	40.0	27.1	14.7	19.1
3	BIHAR	89.9	40.5	66.0	39.4	11.6	26.0	20.1	4.1	12.5
4	GUJARAT	112.3	83.2	98.3	54.6	34.4	44.9	31.2	18.1	24.9
5	HARYANA	87.6	51.1	70.5	64.4	27.1	47.2	32.4	11.7	22.9
6	HIMACHAL PRADESH	108.6	85.0	97.0	85.9	41.0	63.8	38.7	13.9	26.4
7	JAMMU & KASHMIR	81.3	48.7	65.5	48.7	24.2	37.0	25.4	12.5	19.3
8	KARNATAKA	96.7	76.3	86.6	49.5	25.4	37.7	28.2	12.9	20.7
9	KERALA	109.9	104.5	107.2	94.4	84.4	89.4	68.2	55.9	62.1
10	MADHYA PRADESH	90.6	45.2	68.2	48.2	17.4	33.4	28.8	9.6	19.8
11	MAHARASHTRA	114.5	92.2	103.7	62.1	38.7	50.9	34.7	18.0	26.7
12	MANIPUR	125.7	133.2	114.6	60.8	41.0	51.0	40.9	24.0	32.5
13	MEGHALAYA	64.5	57.2	69.9	31.6	28.3	30.0	18.7	16.5	17.6
14	NAGALAND	103.7	83.4	93.8	45.4	34.2	40.0	19.7	11.0	15.6
15	ORISSA	93.0	60.3	76.6	41.1	20.0	30.6	31.9	12.3	22.2
16	PUNJAB	104.5	96.3	100.7	68.3	48.8	59.1	36.0	24.5	30.5
17	RAJASTHAN	86.5	30.0	59.2	46.7	12.0	30.0	34.5	7.8	21.8
18	SIKKIM	122.6	85.9	104.6	43.7	25.1	34.8	10.9	6.0	8.6
19	TAMIL NADU	122.0	103.3	112.8	69.4	42.9	56.3	34.4	17.9	26.2
20	TRIPURA	121.4	93.6	107.7	48.2	34.5	41.5	27.4	18.2	22.9
21	UTTAR PRADESH	81.8	40.3	62.5	56.3	18.0	38.7	39.4	11.3	32.1
22	WEST BENGAL	105.4	81.9	93.9	53.3	37.0	45.3	29.0	21.7	25.4
23	A & N ISLANDS	118.8	106.2	112.7	75.9	58.6	67.8	35.5	28.5	32.3
24	ARUNACHAL PRADESH	94.5	50.7	73.2	29.0	13.4	21.5	13.2	4.8	9.2
25	CHANDIGARH	60.4	56.8	58.8	57.4	50.7	54.4	29.8	28.2	29.1
26	DADRA & NAGAR HAVELI	116.2	77.0	97.0	34.8	17.2	26.1	13.5	7.5	13.5
27	DELHI	91.6	51.9	71.8	82.1	71.8	77.4	51.0	44.6	43.1
28	GOA, DAMAN & DIU	125.2	113.8	119.7	87.4	73.3	80.6	39.6	32.1	36.0
29	LAKSHADWEEP	150.0	124.1	137.1	105.4	65.4	86.1	58.5	29.7	46.1
30	MIZORAM	82.6	74.2	78.4	52.2	45.0	48.6	28.0	21.9	25.0
31	PONDICHEERY	113.9	94.4	104.1	82.1	59.5	71.3	47.0	26.5	37.0
	INDIA	95.8	64.1	80.5	54.3	28.6	41.9	34.2	15.4	25.2

* It does not include enrolment pertaining to Intermediate/Pre-University Classes.

TABLE NO. 4.3(b)
Gross Enrolment Ratio at different levels - States and Union Territories - 1990 - 91

S.No.	State/Union Territories	Primary Classes I-V(6-11 years)			Middle classes VI-VIII(11-14 years)			High/Higher Sec./Intermediate Classes IX-XII(15-17)		
		Boys	Girls	Total	Boys	Girls	Total	Boys	Girls	Total
1	2	3	4	5	6	7	8	9	10	11
1	ANDHRA PRADESH	123.05	94.51	108.95	67.19	40.65	54.03	30.91	1.43	4.00
2	ARUNACHAL PRADESH	121.38	58.14	104.88	54.64	33.34	45.14	29.52	14.64	22.30
3	ASSAM	109.70	89.65	99.95	60.27	43.88	52.35	26.86	18.14	22.66
4	BIHAR	107.71	57.31	82.90	52.50	19.71	36.15	18.02	5.12	11.74
5	GOA	108.28	97.52	102.90	113.83	98.57	106.22	58.93	50.87	54.98
6	GUJARAT	140.28	110.40	125.63	77.71	50.47	64.35	38.36	25.29	32.05
7	HARYANA	97.32	76.11	86.76	78.61	50.52	65.23	35.77	20.70	29.00
8	HIMACHAL PRADESH	117.24	105.83	111.55	109.00	84.14	96.70	60.06	36.34	48.33
9	JAMMU & KASHMIR	102.77	72.03	87.79	76.57	47.29	62.39	32.70	17.25	25.24
10	KARNATAKA	116.13	101.52	108.99	68.36	47.79	58.19	37.25	22.32	29.82
11	KERALA	103.80	101.77	102.80	106.89	103.93	105.43	39.43	40.87	40.14
12	MADHYA PRADESH	120.38	90.83	106.13	76.77	36.09	56.99	31.66	10.92	21.47
13	MAHARASHTRA	132.46	118.26	125.54	90.24	66.43	78.62	40.39	24.73	32.80
14	MANIPUR	118.74	105.08	112.06	69.75	61.33	65.59	40.10	28.73	34.48
15	MEGHALAYA	67.38	60.76	64.06	38.77	38.02	38.39	13.72	12.50	13.10
16	MIZORAM	153.36	146.08	149.81	78.27	79.41	78.83	24.68	24.37	24.53
17	NAGALAND	113.23	99.11	106.29	67.26	63.00	65.17	21.20	18.89	20.09
18	ORISSA	131.48	95.36	113.85	67.72	41.21	54.55	27.77	12.70	20.23
19	PUNJAB	99.59	92.90	96.39	80.89	67.82	74.73	41.39	32.91	37.43
20	RAJASTHAN	106.43	50.33	79.19	67.85	21.73	45.52	34.10	10.38	23.22
21	SIKKIM	130.01	115.15	122.67	46.84	45.12	46.01	23.29	18.59	21.09
22	TAMIL NADU	141.08	126.48	133.95	107.95	83.09	95.75	43.98	29.80	37.01
23	TRIPURA	143.97	122.70	133.51	80.16	64.72	72.59	35.67	24.61	30.28
24	UTTAR PRADESH	89.13	50.98	71.06	63.16	25.62	45.46	34.79	11.15	23.82
25	WEST BENGAL	123.91	103.50	113.87	114.10	75.22	94.69	34.62	19.69	27.33
26	A & N ISLANDS	101.45	85.98	93.51	89.87	77.13	83.68	50.62	46.92	48.86
27	CHANDIGARH	61.07	60.07	60.60	53.90	57.50	55.56	45.67	50.56	47.82
28	DADRA & NAGAR HAVELI	111.60	84.89	98.88	55.29	34.00	45.08	24.22	15.60	20.09
29	DAMAN & DIU	.NA	.NA	.NA	.NA	.NA	.NA	.NA	.NA	.NA
30	DELHI	86.79	94.67	90.43	90.45	82.77	86.96	49.96	53.23	51.42
31	LAKSHADWEEP	151.23	132.87	142.05	116.19	69.87	103.45	52.50	35.60	44.05
32	PONDICHERRY	147.32	136.14	141.79	134.00	112.94	123.56	49.09	39.72	44.38
	INDIA	113.95	85.47	100.10	76.56	46.98	62.14	33.89	10.27	19.28

TABLE NO. 4.4

TEACHER PUPIL RATIO(AV. NO OF STUDENTS PER TEACHER) IN SCHOOLS
FOR GENERAL EDUCATION - STATE AND UTs. 1980-81 & 1990-91

Sl. No.	State/Union Territories	Pre- Primary Schools		Primary Schools		Middle Schools		High/Higher Sec./ Intermediate Universities/Junior Colleges	
		1980-81	1990-91	1980-81	1990-91	1980-81	1990-91	1980-81	1990-91
1	2	3	4	5	6	7	8	9	10
1	ANDHRA PRADESH	50	41	50	53	38	47	27	34
2	ARUNACHAL PRADESH	41	51	28	29	19	21	22	23
3	ASSAM	38	47	35	43	23	25	23	22
4	BIHAR	19	27	40	50	34	42	31	36
5	GOA	41	0	28	21	30	17	28	28
6	GUJARAT	43	44	41	44	38	41	27	29
7	HARYANA	33	36	39	38	33	45	32	34
8	HIMACHAL PRADESH	32	31	36	34	14	19	23	32
9	JAMMU & KASHMIR	0	0	25	26	19	22	18	20
10	KARNATAKA	80	50	43	44	45	52	26	29
11	KERALA	34	30	34	32	32	32	30	29
12	MADHYA PRADESH	38	39	37	42	27	31	25	29
13	MAHARASHTRA	39	40	39	39	36	38	29	32
14	MANIPUR	13	11	17	17	16	11	22	17
15	MEGHALAYA	44	39	29	36	17	19	23	22
16	MIZORAM	0	0	30	28	14	14	20	18
17	NAGALAND	0	0	20	22	13	19	23	26
18	ORISSA	12	0	33	41	19	27	12	21
19	PUNJAB	25	22	40	39	17	22	24	31
20	RAJASTHAN	29	25	40	41	28	30	23	24
21	SIKKIM	32	28	21	15	20	15	21	19
22	TAMIL NADU	42	47	39	46	35	46	26	35
23	TRIPURA	33	41	43	25	27	25	21	23
24	UTTAR PRADESH	27	37	37	45	24	28	30	38
25	WEST BENGAL	28	38	35	47	44	45	32	40
26	A & N ISLANDS	30	31	21	21	18	21	21	20
27	CHANDIGARH	0	0	20	21	30	20	23	28
28	DADRA & NAGAR HAVELI	34	0	50	45	32	33	20	25
29	DAMAN & DIU	0	0	0	35	0	33	0	28
30	DELHI	46	51	35	37	24	23	24	25
31	LAKSHADWEEP	25	40	34	24	28	23	19	15
32	PONDICHERY	43	49	28	27	30	28	27	30
	INDIA	44	44	38	43	33	37	27	31

2 Daman & Diu was part of U.T. of Goa. Daman and Diu in the year 1980-81.

TABLE NO. 4.5

ALL INDIA DROPOUT RATES OF STUDENTS OF SCHOOLS FOR GENERAL EDUCATION FROM 1980-81 TO 1994-95

Sno.	State/Union Territories	Primary Stages Classes (I - V)			Middle Stages Classes (I - VIII)			High School Stages Classes (I - X)		
		BOYS	GIRLS	TOTAL	BOYS	GIRLS	TOTAL	BOYS	GIRLS	TOTAL
1	2	3	4	5	6	7	8	9	10	11
1	1980-81	56.20	62.50	58.70	68.00	79.40	72.70	79.80	86.63	82.46
2	1981-82	51.10	57.30	53.50	68.50	77.70	72.10	79.44	86.81	82.33
3	1982-83	49.40	56.30	52.10	66.04	74.96	69.57	78.21	86.24	81.37
4	1983-84	47.83	53.96	50.26	66.10	75.27	69.26	76.41	84.79	79.71
5	1984-85	45.62	51.41	47.93	61.83	70.87	65.39	74.71	83.34	78.13
6	1985-86	45.84	50.27	47.61	60.70	70.04	64.42	73.97	83.16	77.62
7	1986-87	46.87	51.17	48.60	61.44	70.16	64.90	73.27	81.31	76.44
8	1987-88	43.28	49.42	46.97	58.80	67.55	62.29	72.14	80.06	75.30
9	1988-89	46.74	49.69	47.93	59.38	68.31	65.40	72.68	79.46	75.36
10	1989-90	46.50	50.35	48.08	61.00	68.75	64.09	70.99	77.72	73.66
11	1990-91	40.10	45.97	42.60	59.12	65.13	60.91	67.50	76.96	71.34
12	1991-92(P)	41.03	45.17	42.78	54.30	62.04	57.48	68.55	75.87	71.51
13	1992-93(P)	40.07	43.02	41.30	53.99	60.06	56.48	68.15	74.69	70.80
14	1993-94(P)	36.07	39.05	37.32	49.55	56.78	52.80	68.41	74.54	70.90
15	1994-95(P)	35.18	37.79	36.27	50.02	56.53	52.74	67.15	73.78	69.89

(P) The dropout Rates are calculated on the basis of Provisionals data available for these years.

Statewise Dropout Rates of Students of Schools for General Education 1990-91

Sno.	State/Union Territories	Primary Stages(Classess I-V)			Middle Stages(Classess I-VIII)			High School Stages (Classess I-X)		
		BOYS	GIRLS	TOTAL	BOYS	GIRLS	TOTAL	BOYS	GIRLS	TOTAL
1	2	3	4	5	6	7	8	9	10	11
1	ANDHRA PRADESH	48.55	56.05	51.87	69.08	78.07	72.93	76.68	84.63	80.06
2	ARUNACHAL PRADESH	60.71	60.78	60.73	76.36	75.84	76.16	79.10	82.20	80.22
3	ASSAM	45.97	59.77	52.42	71.44	72.93	72.09	79.82	83.39	81.37
4	BIHAR	63.24	66.88	64.47	76.85	83.90	79.15	82.75	89.50	84.88
5	GOA	-8.59	1.79	-3.64	14.31	20.09	17.05	50.22	53.40	51.72
6	GUJARAT	38.71	48.84	43.27	52.89	64.15	57.82	68.60	74.22	70.99
7	HARYANA	17.97	28.70	22.66	34.09	47.78	39.69	59.02	67.87	62.39
8	HIMACHAL PRADESH	33.00	32.84	32.93	26.69	36.02	30.93	44.90	57.66	50.59
9	JAMMU & KASHMIR	53.46	41.25	48.48	43.09	70.78	54.19	67.85	78.94	72.18
10	KARNATAKA	41.37	51.33	46.12	54.70	70.35	62.34	67.66	78.69	73.01
11	KERALA	-8.90	-6.87	-7.91	3.16	4.15	3.64	41.99	34.96	38.57
12	MADHYA PRADESH	29.47	30.50	33.16	54.38	70.94	60.78	69.70	84.71	73.91
13	MAHARASHTRA	29.16	38.87	33.73	47.30	61.85	54.07	56.63	75.94	69.44
14	MANIPUR	72.37	73.95	73.11	76.15	76.13	76.14	74.17	78.40	76.09
15	MEGHALAYA	26.49	25.94	26.23	67.32	61.82	64.77	66.03	59.68	63.10
16	MIZORAM	51.62	49.07	50.42	56.47	53.52	55.03	45.43	42.23	43.91
17	NAGALAND	31.46	39.66	35.54	57.50	57.98	57.72	68.97	68.69	68.85
18	ORISSA	46.55	45.62	46.17	55.69	67.79	60.46	72.20	81.17	75.91
19	PUNJAB	24.09	25.11	24.56	40.44	47.55	43.70	56.25	64.62	60.12
20	RAJASTHAN	58.55	66.15	60.90	66.82	75.16	69.17	90.00	92.28	90.59
21	SIKKIM	60.73	52.94	57.31	80.29	77.73	79.17	84.92	85.98	85.39
22	TAMIL NADU	18.27	22.68	20.31	40.16	49.43	44.47	64.68	72.97	68.52
23	TRIPURA	62.02	63.35	62.63	71.73	72.18	71.93	83.54	85.70	84.51
24	UTTAR PRADESH	30.67	42.42	34.82	54.97	65.60	58.32	58.37	78.05	64.71
25	WEST BENGAL	43.21	56.68	49.16	55.21	60.23	57.36	84.51	85.85	85.07
26	A & N ISLANDS	0.74	6.83	3.63	29.56	35.82	32.49	60.14	62.23	61.13
27	CHANDIGARH	3.95	0.53	1.89	a	16.11	0.93	10.40	0.51	6.01
28	DADRA & NAGAR HAV	35.24	53.65	43.28	53.39	61.45	56.76	76.53	83.06	79.33
29	DAMAN & DIU	a	a	a	a	a	a	a	a	a
30	DELHI	21.38	26.23	23.72	-5.54	17.33	5.60	24.59	33.17	28.69
31	LAKSHADWEEP	17.96	27.70	22.69	28.28	43.36	35.62	67.15	75.75	71.28
32	PONDICHERY	-5.37	-12.08	-8.48	10.44	11.21	0.02	50.92	54.37	52.57
	INDIA	40.10	45.97	42.60	59.12	65.13	62.91	67.50	76.96	71.34

a Daman & Diu was part of U.T. of Goa, Daman and Diu in the year 1980-81.

* Included in Goa

TABLE - 4.7

EFFICIENCY IN EDUCATION

Efficiency is a concept which has been developed and refined by economists. It refers to the relationship between the inputs into the system and the outputs from that system. An activity is said to be 'efficient' if maximum output is being obtained from given inputs, or if a given output is being obtained with the minimum possible inputs. Educational inputs comprise the buildings, teachers, text books, teaching aids, equipments, science labs., libraries, school campus etc. which may all be aggregated financially in terms of expenditure per student year. This exercise is rather cumbersome. Therefore, an input indicator appropriate for the measure of output in terms of successful completers is the number of pupil years used by cohort. In a system consisting of 5 to 8 grades a minimum of five pupil years or eight pupil years would be required for pupils to complete successfully the cycle. However, perfect efficiency is almost never achieved in the real world. Pupil repeat grades, so increasing the number of pupil years. Students drop out before completing the school, thus diminishing output. This definition of efficiency of education is comparatively narrow and is not an economic definition because it ignores the financial costs of inputs and the monetary values of outputs. However, it is a fairly useful indicator for comparative analysis of the effects of repetition and drop outs. For describing the flow of students certain statistics must be calculated as under:

- (i) Students may be promoted to next higher grade.
 - (ii) Students may repeat the same grade during the following year.
 - (iii) Students may drop out for various reasons.
- These may be calculated in the following manner:

(a) The Promotion Rate: (p_i^t)

$$(p_i^t) = \frac{\text{No. of students promoted to grade } i+1 \text{ in year } t+1}{\text{No. of students in grade } (i) \text{ in year } t.}$$

- Symbolically: $(p_i^t) = \frac{(p_{i+1}^{t+1})}{(E_i^t)}$

(b) The Repetition Rate (r_i^t)

$$(r_i^t) = \frac{\text{No. of students repeating grade } i \text{ in year } t+1}{\text{No. of students in grade } i \text{ in year } t}$$

Symbolically: $(r_i^t) = \frac{(r_i^{t+1})}{(E_i^t)}$

(c) The Rate of Dropouts: (d_i^t)

$$(d_i^t) = \frac{\text{No. of students dropping out from grade } i \text{ in year } t}{\text{No. of student in grade } i \text{ in year } t}$$

$$\text{-Symbollically: } (d_i^t) = \frac{(E_i^t) - (R_i^{t+1} + P_{i+1}^{t+1})}{(E_i^t)}$$

The enrolment and repeaters in primary classes i.e. classes I-V for the years 1984 to 1988 are given school-wise and sex-wise in table given below:

TABLE 1
ENROLMENT AND REPEATERS: PRIMARY EDUCATION M.F. (combined)

Year		1	2	3	4	5
1984	Enrolment	23916348	20234611	16243180	13641699	11614953
	Repeaters	1007822	658519	570222	624395	544733
1985	Enrolment	26030667	18305727	16599089	14421482	12083549
	Repeaters	1199933	760971	7165525	694513	531890
1986	Enrolment	23422880	20405986	16622384	14281182	12402789
	Repeaters	1034602	602199	587710	684870	509662
1987	Enrolment	24281805	21048937	17262074	14825709	13041372
	Repeaters	1077655	604697	633327	711051	410983
1988	Enrolment	25847370	19848007	17473606	14987438	13114740
	Repeaters	1138349	543595	543696	674368	680574

ENROLMENT AND REPEATERS: PRIMARY EDUCATION: MALES

1984	Enrolment	14075115	12251591	9879784	8415680	7299736
	Repeaters	596564	385703	326268	362995	322970
1985	Enrolment	15328881	10704978	9929375	87963181	7489859
	Repeaters	704777	438106	426563	414399	315491
1986	Enrolment	13468846	12109782	9846365	8608665	7649491
	Repeaters	596762	351014	344413	428865	311803
1987	Enrolment	13975278	12463626	10164847	8890485	8013885
	Repeaters	626312	360442	381406	442570	170708
1988	Enrolment	15087638	11588615	10216378	8949873	7993476
	Repeaters	668020	313726	324581	418344	429774

ENROLMENT AND REPEATERS: PRIMARY EDUCATION : FEMALES

1984	Enrolment	9841233	7983020	6368396	5226019	4315217
	Repeaters	411258	272816	243954	261400	221763
1985	Enrolment	10701786	7600749	6669214	5628301	4593690
	Repeaters	495156	322865	289962	280114	216399
1986	Enrolment	9954034	8300204	6766019	5672517	4753298
	Repeaters	437840	251185	243297	256005	197859
1987	Enrolment	10306527	8585311	7097227	5935224	5027487
	Repeaters	451343	244255	256921	268481	240275
1988	Enrolment	10759732	8259392	7257228	6037565	5121264
	Repeaters	470329	229869	219115	256024	250800

On the basis of these enrolment and repeaters data, the rates promotion, repetition and drop outs for classes I to V for the years 1984-1987 have been calculated and are given below sex-wise and classwise in table-2

Table 2

PROMOTION, REPETITION AND DROP-OUT RATES
PRIMARY EDUCATION. MF (Combined)

Year	Rate	1	2	3	4	5
1984	Promotion	0.734	0.785	0.845	0.847	0.954
	Repetition	0.050	0.038	0.044	0.051	0.046
	Drop-out	0.216	0.177	0.111	0.102	0.000
1985	Promotion	0.761	0.875	0.819	0.825	0.958
	Repetition	0.040	0.033	0.035	0.047	0.042
	Drop-out	0.199	0.092	0.145	0.128	0.000
1986	Promotion	0.873	0.814	0.850	0.884	0.967
	Repetition	0.046	0.030	0.038	0.050	0.033
	Drop-out	0.081	0.156	0.112	0.066	0.000
1987	Promotion	0.795	0.804	0.829	0.839	0.948
	Repetition	0.047	0.026	0.031	0.045	0.052
	Drop-out	0.158	0.170	0.139	0.116	0.000

PROMOTION, REPETITION AND DROP-OUT RATES
PRIMARY EDUCATION: MALES

1984	Promotion	0.729	0.776	0.848	0.853	0.957
	Repetition	0.050	0.036	0.043	0.049	0.043
	Drop-out	0.220	0.189	0.109	0.098	0.000
1985	Promotion	0.767	0.888	0.824	0.834	0.958
	Repetition	0.039	0.033	0.035	0.049	0.042
	Drop-out	0.194	0.080	0.142	0.117	0.000
1986	Promotion	0.899	0.808	0.858	0.911	0.978
	Repetition	0.047	0.030	0.039	0.051	0.022
	Drop-out	0.055	0.162	0.103	0.038	0.000
1987	Promotion	0.807	0.794	0.839	0.851	0.946
	Repetition	0.048	0.025	0.032	0.047	0.054
	Drop-out	0.145	0.181	0.129	0.102	0.000

PROMOTION, REPETITION AND DROP-OUT RATES.
PRIMARY EDUCATION. FEMALES

1984	Promotion	0.740	0.799	0.840	0.838	0.950
	Repetition	0.050	0.040	0.046	0.054	0.050
	Drop-out	0.210	0.160	0.115	0.109	0.000
1985	Promotion	0.752	0.858	0.812	0.809	0.957
	Repetition	0.041	0.033	0.036	0.045	0.043
	Drop-out	0.207	0.109	0.151	0.145	0.000
1986	Promotion	0.838	0.824	0.838	0.884	0.949
	Repetition	0.045	0.029	0.038	0.047	0.051
	Drop-out	0.117	0.145	0.124	0.109	0.000
1987	Promotion	0.779	0.820	0.815	0.821	0.950
	Repetition	0.046	0.027	0.031	0.043	0.050
	Drop-out	0.175	0.153	0.155	0.136	0.000

Based on the above rates of promotion, repetition and drop-out, diagrams have been prepared which are given below as diagram 1,2 and 3. The diagram relating to primary classes indicates that there had been 3783 pupil years into the system of primary education while the number of candidates passing out of the system was only 538 thereby a student took 7.03 as against normal 5 years. The input : out put ratio in the system during the period 1984 to 1988 has been 1.41 against the ideal ratio of one. The boys took 6.82 years while the females took 7.28 as against the period of normal 5 years. The rates of drop-outs and promotion during this period have been as under:

<u>Stage</u>	<u>Boys</u>	<u>Girls</u>	<u>Total</u>
<u>Primary Stage (I to V Classes)</u>			
Drop outs.	44.5	48.7	46.2
Promotees	55.5	51.3	53.8

On the whole, the promotees and drop out are in the ratio of 54.46 in the primary stage of education. This by no means can be considered to be a very efficient system of education in the country.

DIAGRAM No 1: HYPOTHETICAL FLOW OF THE COHORT OF 1984, PRIMARY EDUCATION
MALE AND FEMALE

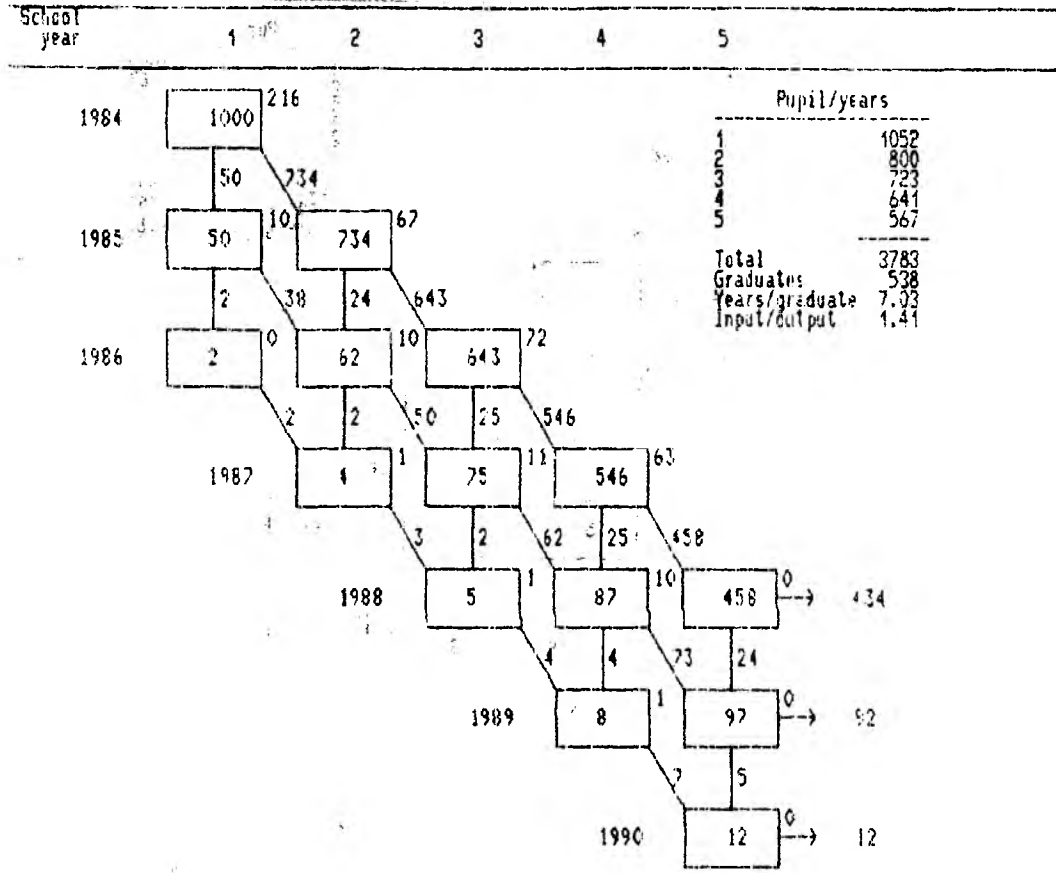

Evolution of the cohort

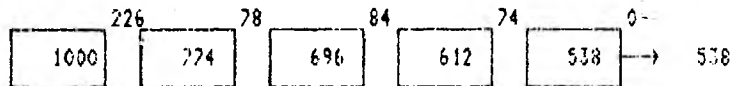
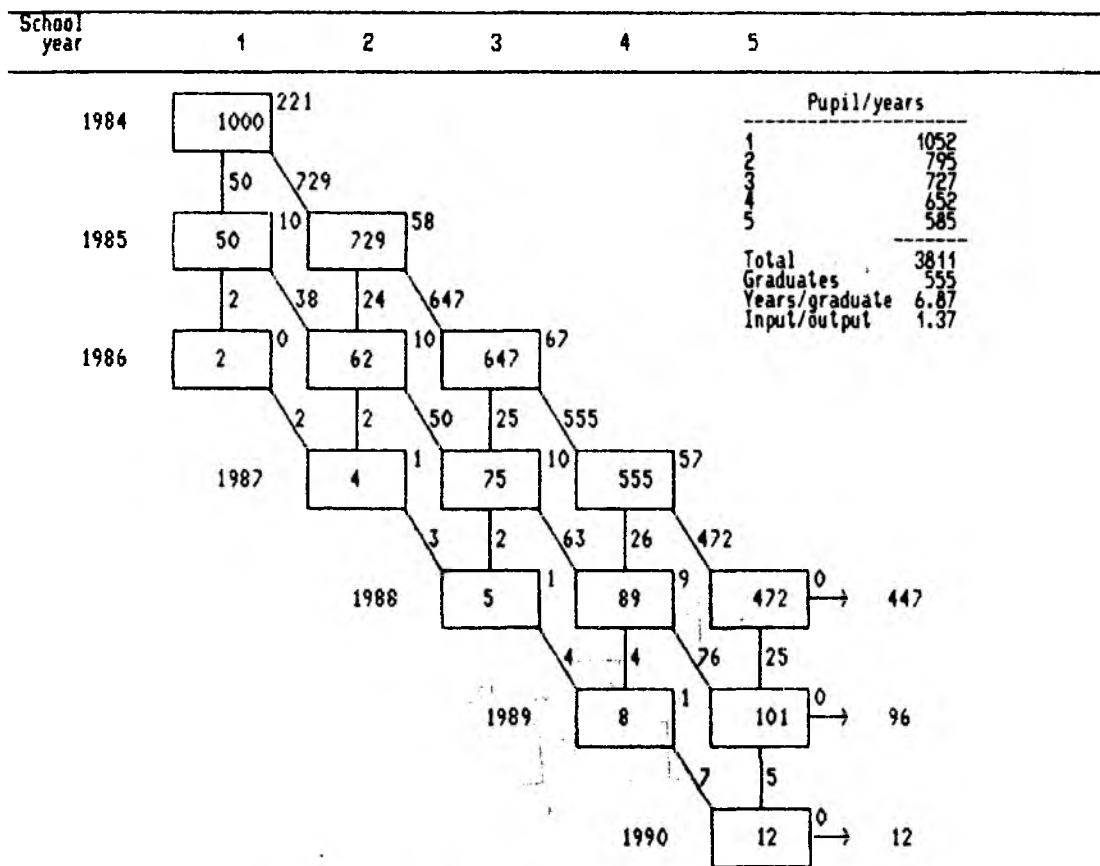

DIAGRAM No 2: HYPOTHETICAL FLOW OF THE COHORT OF 1984. PRIMARY EDUCATION
MALE



Evolution of the cohort

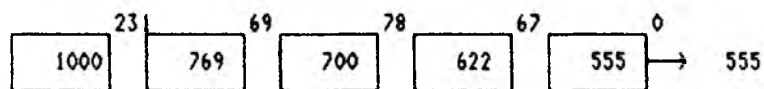
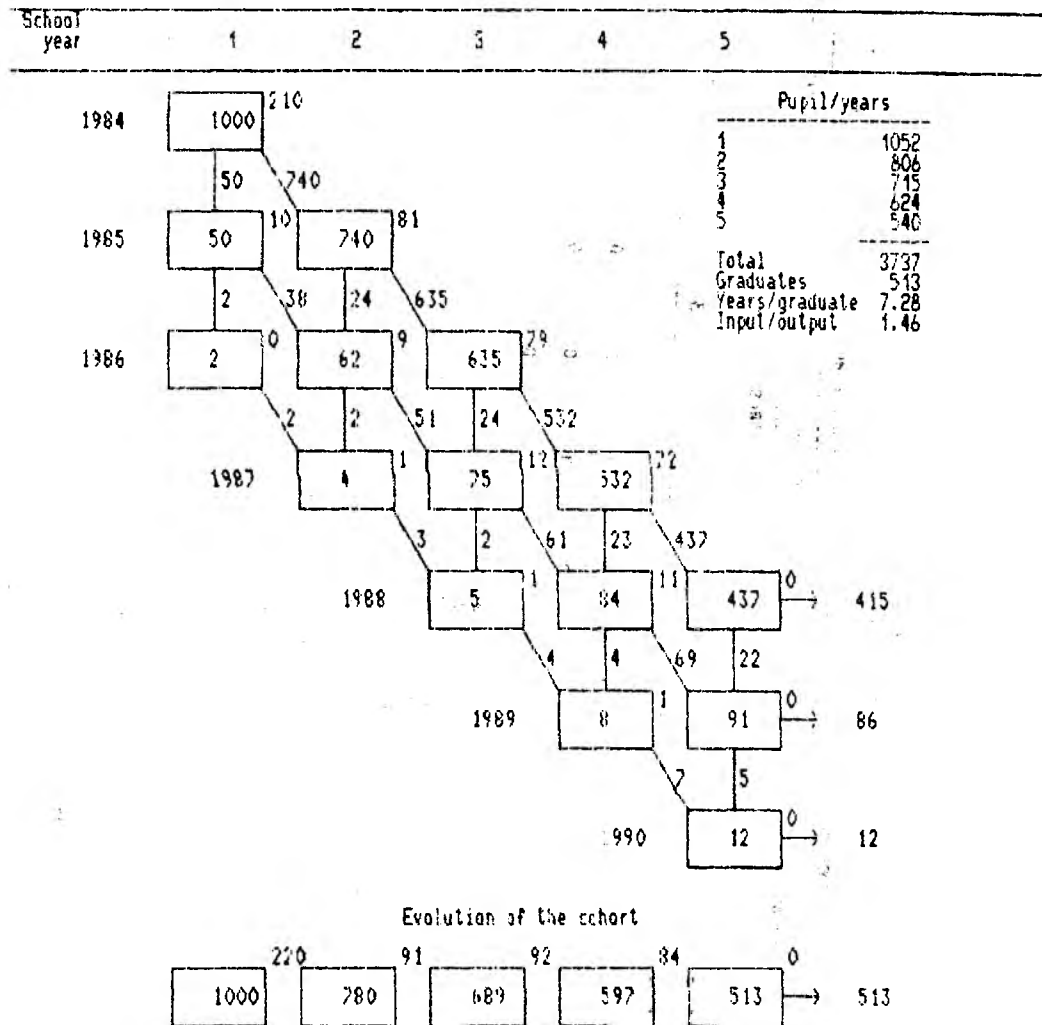

DIAGRAM No 3: HYPOTHETICAL FLOW OF THE COHORT OF 1984. PRIMARY EDUCATION FEMALE



- 58 -
TABLE NO. 4.8

STUDENTS FLOW IN SCHOOL CLASSES(1 TO VIII) AND RETENTION RATES DURING PERIOD 1960-61 TO 1990-91.

S.NO.	YEAR	CLASSES - I		CLASSES - II		CLASSES - III		CLASSES - IV		CLASSES - V		CLASSES - VI		CLASSES - VII		CLASSES - VIII	
		TOTAL	GIRLS	TOTAL	GIRLS	TOTAL	GIRLS	TOTAL	GIRLS	TOTAL	GIRLS	TOTAL	GIRLS	TOTAL	GIRLS	TOTAL	GIRLS
1	2	3	4	5	6	7	8	9	10	11	12	13	14	15	16	17	18
1960-61		13391347 (100.00)	4680909 (100.00)	0	0	0	0	0	0	0	0	0	0	0	0	0	0
1961-62		15746164 (100.00)	5705962 (100.00)	8121148 (60.6)	2736855 (50.5)	0	0	0	0	0	0	0	0	0	0	0	0
1962-63		16404417 (100.00)	6023285 (100.00)	9074988 (57.6)	3116593 (54.6)	6718602 (50.2)	2195442 (46.9)	0	0	0	0	0	0	0	0	0	0
1963-64		16905528 (100.00)	6283003 (100.00)	9824113 (59.9)	3448413 (57.3)	7492545 (47.6)	2515940 (44.1)	5754632 (39.0)	1825649 (39.0)	0	0	0	0	0	0	0	0
1964-65		18240602 (100.00)	6948612 (100.00)	10373531 (61.4)	3752420 (59.7)	8214680 (50.1)	2836778 (47.1)	6425247 (40.8)	2103893 (36.9)	4964247 (37.1)	1524406 (32.6)	0	0	0	0	0	0
1965-66		18883970 (100.00)	7309790 (100.00)	10766539 (59.0)	3954487 (56.9)	8550917 (50.6)	3026630 (48.2)	6882430 (42.0)	2318509 (38.5)	5381366 (34.2)	1683795 (29.5)	4186176 (31.3)	1172329 (25.3)	0	0	0	0
1966-67		19533259 (100.00)	7511283 (100.00)	11164489 (59.1)	4193807 (57.4)	8778725 (48.1)	3158432 (45.5)	7077048 (41.9)	2412912 (38.4)	5710325 (34.8)	1827741 (30.3)	4521541 (28.7)	1289988 (22.6)	3628741 (27.1)	1012614 (21.6)	0	0
1967-68		19750974 (100.00)	7637372 (100.00)	11525904 (59.0)	4323488 (57.6)	9077406 (48.1)	3301410 (45.2)	7304960 (40.0)	2544038 (36.6)	5920639 (35.0)	1946193 (31.0)	4789157 (29.2)	1384299 (23.0)	3950698 (25.1)	1103787 (19.2)	3244645 (24.2)	863354 (18.4)
1968-69		19835890 (100.00)	7695708 (100.00)	11687872 (59.2)	4430437 (58.0)	9299576 (47.6)	3420149 (54.5)	7503170 (39.7)	2654075 (36.3)	6042209 (33.1)	2011469 (28.9)	4932422 (29.2)	1634104 (22.9)	4144380 (25.3)	1176795 (19.5)	3459461 (22.0)	936647 (16.4)
1969-70		19942055 (100.00)	7778779 (100.00)	12004466 (60.5)	4562462 (59.3)	9546595 (48.3)	3521830 (46.1)	7742453 (39.6)	2752492 (36.6)	6249417 (33.1)	2100326 (28.7)	5063780 (27.8)	1482830 (21.3)	4298198 (25.4)	1231592 (19.6)	3616774 (22.0)	989776 (16.4)
1970-71		20438788 (100.00)	7924508 (100.00)	12392653 (62.1)	4725426 (60.7)	9817767 (49.5)	3635682 (47.2)	7941072 (40.2)	2836167 (37.1)	6455109 (33.0)	2184437 (21.9)	5192411 (27.5)	1559878 (21.3)	4378808 (24.5)	1287103 (18.5)	3743951 (22.1)	1042492 (16.6)
1971-72		21118992 (100.00)	8213094 (100.00)	12757559 (62.4)	4830953 (61.0)	10150659 (50.9)	3786292 (48.7)	8167693 (41.2)	2938463 (38.2)	6623731 (33.5)	2265014 (29.7)	5329260 (27.3)	1618205 (21.5)	4518654 (23.9)	1333786 (18.2)	3835751 (21.0)	1090540 (15.7)
1972-73		22183109 (100.00)	8710611 (100.00)	14036917 (66.5)	5366167 (65.3)	10646473 (52.1)	3977046 (50.2)	8584626 (43.0)	3118415 (40.1)	6949504 (35.0)	2406786 (31.3)	5604567 (28.4)	1730061 (22.7)	4696984 (24.0)	1420750 (18.9)	3955524 (20.9)	1151880 (15.8)
1973-74		21550516 (100.00)	85044878 (100.00)	14576201 (65.7)	5597736 (64.3)	11295878 (53.5)	4262112 (31.7)	8846236 (43.3)	3274534 (41.3)	7179048 (36.0)	2554553 (29.3)	5810548 (24.2)	1862098 (24.7)	4869895 (24.7)	1525091 (20.0)	4040378 (20.7)	1176798 (15.7)
1974-75		21975542 (100.00)	8669345 (100.00)	14636168 (67.9)	5606111 (65.9)	11573409 (52.2)	4340317 (49.8)	9154776 (43.3)	3337323 (40.6)	7515743 (36.8)	2636002 (33.3)	6174784 (31.0)	1973922 (25.4)	4976915 (25.1)	1564382 (20.3)	4214680 (21.3)	1245816 (16.3)

1	2	3	4	5	6	7	8	9	10	11	12	13	14	15	16	17	18
1975-76	21987533 (100.00)	8712804 (100.00)	14583523 (64.4)	5623811 (64.9)	11901284 (55.2)	4482708 (52.7)	9339026 (42.1)	3414160 (39.2)	7848656 (37.2)	2777442 (33.8)	6268389 (30.7)	2026002 (25.6)	5318639 (26.7)	1687224 (21.7)	4436764 (22.4)	1320559 (17.2)	
1976-77	22724536 (100.00)	9185204 (100.00)	15636757 (64.6)	5955544 (55.4)	12467678 (56.7)	4684055 (54.0)	10043982 (46.6)	3654291 (43.0)	8187777 (36.9)	2891726 (33.2)	6638145 (31.4)	2175732 (26.5)	5493790 (26.9)	1755255 (22.1)	4554847 (22.8)	1385322 (17.8)	
1977-78	21127331 (100.00)	8428795 (100.00)	15740220 (69.3)	5934623 (64.6)	12187150 (55.4)	4528292 (52.0)	9931333 (45.2)	3617851 (41.7)	8374954 (38.9)	2952175 (34.7)	6862428 (30.9)	2248742 (25.8)	5719733 (27.1)	1852277 (22.6)	4721813 (23.1)	1453672 (18.3)	
1978-79	21639468 (100.00)	8721757 (100.00)	15835232 (75.0)	6044705 (71.7)	12777637 (56.2)	4823740 (52.5)	10230222 (46.5)	3786152 (43.5)	8478011 (38.6)	3011600 (34.7)	7185175 (33.3)	2387191 (28.1)	598031 (27.0)	1959864 (22.5)	5012525 (23.7)	1583564 (19.3)	
1979-80	21593833 (100.00)	8688807 (100.00)	16745185 (77.4)	6344133 (75.3)	13413416 (63.5)	5077015 (60.2)	10912365 (48.0)	4049840 (44.1)	8893290 (40.4)	3179541 (36.5)	7525816 (34.2)	2497144 (28.8)	6394383 (29.7)	2083913 (24.5)	5358703 (24.2)	1666368 (19.1)	
1980-81	23052579 (100.00)	9075675 (100.00)	15494346 (71.8)	6135216 (70.6)	13908653 (64.3)	5370254 (61.6)	11632897 (55.1)	4347402 (51.6)	9685712 (42.6)	3519509 (38.3)	8047749 (36.6)	2099959 (31.0)	6833856 (31.0)	2265666 (26.1)	5842759 (27.1)	1824774 (21.5)	
1981-82	22165341 (100.00)	9006206 (100.00)	17533893 (76.1)	6737474 (74.2)	14180938 (65.7)	5426870 (62.5)	12065551 (55.8)	4543269 (52.1)	10160185 (48.1)	3680911 (45.7)	8557626 (37.7)	2877968 (31.3)	7180053 (32.6)	2417477 (27.7)	6208509 (28.3)	1954233 (22.5)	
1982-83	24979601 (100.00)	9970940 (100.00)	16652910 (75.1)	6663841 (74.0)	14752065 (64.0)	5698697 (62.8)	12472872 (57.8)	4722524 (54.4)	10649497 (49.2)	3879008 (44.5)	9256046 (37.7)	3180499 (37.7)	7684782 (33.8)	2605395 (28.4)	6690257 (30.4)	2182019 (25.0)	
1983-84	25552180 (100.00)	10214775 (100.00)	17445441 (69.9)	7005978 (70.3)	15385305 (69.4)	5968061 (66.3)	13035935 (56.5)	4948149 (54.5)	11151109 (51.6)	4093937 (47.1)	9821115 (45.4)	3381588 (38.8)	8277803 (39.2)	2852065 (33.8)	7095591 (31.2)	2318244 (25.2)	
1984-85	23916348 (100.00)	9841233 (100.00)	20234611 (79.2)	7983020 (78.2)	16248180 (65.0)	6368396 (63.9)	13641699 (61.5)	5226019 (58.0)	11614953 (50.4)	4315217 (47.5)	10104922 (46.8)	3549724 (40.9)	8576887 (39.6)	2952944 (33.9)	7533760 (35.7)	2496550 (29.6)	
1985-86	26030667 (100.00)	10701786 (100.00)	18305727 (76.5)	7600749 (72.2)	16599089 (65.0)	6669214 (65.3)	14421482 (57.7)	5628301 (56.4)	12083549 (54.5)	4593690 (51.0)	10455579 (45.4)	3747476 (41.3)	8971349 (41.5)	3180727 (36.6)	7882927 (36.4)	2645554 (30.3)	
1986-87	23422880 (100.00)	9954034 (100.00)	20409986 (78.4)	8300204 (77.6)	16612384 (69.5)	6766019 (68.8)	14281182 (55.9)	5672517 (55.5)	12402789 (49.7)	4753298 (47.7)	10567326 (47.7)	3767330 (41.8)	8047099 (39.0)	3177587 (35.0)	7028529 (36.7)	2675736 (30.8)	
1987-88	24281805 (100.00)	10308527 (100.00)	21048937 (89.9)	8585311 (86.2)	17262074 (66.3)	7097227 (66.3)	14825709 (62.0)	5935224 (60.3)	13041372 (51.0)	5027487 (49.2)	11224547 (44.9)	4063438 (40.8)	9597535 (43.3)	3443705 (38.2)	8444866 (36.7)	2901365 (32.0)	
1988-89	25847370 (100.00)	10759732 (100.00)	19848007 (81.7)	8259392 (80.1)	17473606 (74.6)	7257228 (72.9)	14987438 (57.6)	6037565 (56.4)	13114740 (54.8)	5121264 (52.0)	11541441 (45.2)	4201218 (41.1)	9817420 (39.3)	3544651 (35.5)	8591126 (38.8)	2936372 (32.6)	
1989-90	23592022 (100.00)	10049265 (100.00)	22018844 (85.2)	9064857 (84.2)	17831736 (73.4)	7460469 (72.4)	15394296 (65.7)	6191739 (62.2)	13514160 (51.9)	5313047 (49.6)	11862030 (49.6)	4309697 (43.8)	10058237 (39.4)	3641361 (35.6)	8968554 (35.9)	3115092 (31.2)	
1990-91	27061773 (100.00)	11466003 (100.00)	20999418 (89.0)	8867818 (88.2)	18866063 (73.0)	7886317 (73.3)	16151731 (66.5)	6584682 (63.9)	14296315 (61.0)	5615536 (56.4)	12913997 (49.6)	4850561 (45.3)	11125924 (46.5)	4126301 (41.9)	9986066 (39.1)	3562019 (34.9)	

TABLE NO 4.9
Statewise Attrition Rates of Teachers - 1984

PRIMARY SCHOOLS							
NUMBER OF TEACHERS WHO LEFT THE PROFESSION							
STATE/UNION TERRITORY	AT THE BEG- INNING OF THE SESSION	RETIRED/ DIED	RESIGNED/ TERMINAT- ED	TRANS- FERED	TOTAL COL 4 TO 6	PER- CENTAGE	
1	2	3	4	5	6	7	8
1	ANDHRA PRADESH	94442	1548	159	757	2464	2.61
2	ARUNACHAL PRADESH	1690	5	1	6	12	0.71
3	ASSAM	56017	90	8	6	104	0.19
4	BIHAR	111892	689	30	0	719	0.64
5	GOA	2895	11	14	5	30	1.04
6	GUJARAT	30776	405	420	112	937	3.04
7	HARYANA	15763	112	26	13	151	0.96
8	HIMACHAL PRADESH	16489	89	14	18	121	0.73
9	JAMMU & KASHMIR	11620	30	11	75	116	1.00
10	KARNATAKA	37312	169	38	410	617	1.65
11	KERALA	48296	1313	328	237	1878	3.89
12	MADHYA PRADESH	155017	646	788	531	1965	1.27
13	MAHARASHTRA	115418	1473	1054	566	3093	2.68
14	MANIPUR	8665	40	13	3	56	0.65
15	MEGHALAYA	6817	37	15	10	62	0.91
16	MIZORAM	3296	16	10	1	27	0.82
17	NAGALAND	5281	49	19	4	72	1.36
18	ORISSA	74823	390	79	159	628	0.84
19	PUNJAB	47274	273	29	310	612	1.29
20	RAJASTHAN	60437	201	1897	176	2274	3.76
21	SIKKIM	1768	3	33	5	41	2.32
22	TAMIL NADU	112923	1470	229	234	1933	1.71
23	TRIPURA	7236	45	6	35	86	1.19
24	UTTAR PRADESH	264230	1951	429	697	3077	1.16
25	WEST BENGAL	169405	2134	210	0	2344	1.38
26	A & N ISLANDS	574	6	0	1	7	1.22
27	CHANDIGARH	346	1	16	0	17	4.91
28	DADRA & NAGAR HAVELI	175	2	0	0	2	1.14
29	DAMAN & DIU	181	1	0	0	1	0.55
30	DELHI	18126	64	108	18	190	1.05
31	LAKSHADWEEP	184	1	0	0	1	0.54
32	PONDICHERRY	1667	10	27	1	38	2.28
	INDIA	1481485	13274	6011	4390	23675	1.60

(CONTD..)

TABLE NO 4.9

Statewise Attrition Rates of Teachers - 1986(Contd..)

MIDDLE SCHOOLS							
NUMBER OF TEACHERS WHO LEFT THE PROFESSION							
STATE/UNION TERRITORY	AT THE BEG- INNING OF THE SESSION	RETIRED/ DIED	RESIGNED/ TERMINAT- ED	TRANS- FERED	TOTAL COL. 10 TO 12	PER- CENTAGE	
1	2	9	10	11	12	13	14
1	ANDHRA PRADESH	38904	433	150	162	745	1.91
2	ARUNACHAL PRADESH	1134	3	6	5	14	1.23
3	ASSAM	29560	45	4	0	49	0.17
4	BIHAR	90703	543	32	9	584	0.64
5	GOA	1115	5	8	1	14	1.26
6	GUJARAT	122899	1262	1495	375	3132	2.55
7	HARYANA	10709	53	41	3	97	0.91
8	HIMACHAL PRADESH	5580	10	8	2	20	0.36
9	JAMMU & KASHMIR	15400	30	45	57	132	0.86
10	KARNATAKA	95054	273	146	600	1019	1.07
11	KERALA	54914	1068	283	286	1637	2.98
12	MADHYA PRADESH	71742	222	498	222	942	1.31
13	MAHARASHTRA	129568	2001	976	561	3538	2.73
14	MANIPUR	3638	12	4	0	16	0.44
15	MEGHALAYA	2953	4	29	9	42	1.42
16	MIZORAM	2656	6	19	7	32	1.20
17	NAGALAND	2929	16	39	8	63	2.15
18	ORISSA	34792	83	57	19	159	0.46
19	PUNJAB	10720	69	7	92	168	1.57
20	RAJASTHAN	67067	145	699	301	1145	1.71
21	SIKKIM	1349	6	14	3	23	1.70
22	TAMIL NADU	62063	663	92	94	849	1.37
23	TRIPURA	3628	12	0	23	35	0.96
24	UTTAR PRADESH	99295	895	413	143	1451	1.46
25	WEST BENGAL	41882	218	57	11	286	0.68
26	A & N ISLANDS	555	4	4	2	10	1.80
27	CHANDIGARH	423	1	11	1	13	3.07
28	DADRA & NAGAR HAVELI	339	4	7	0	11	3.24
29	DAMAN & DIU	159	0	0	0	0	0.00
30	DELHI	4512	13	56	2	71	1.57
31	LAKSHADWEEP	114	0	0	0	0	0.00
32	PONDICHERRY	1414	4	11	1	16	1.13
	INDIA	1007770	8103	5211	2999	16313	1.62

(CONTD..)

TABLE NO 4.9

Statewise Attrition Rates of Teachers - 1986(Contd..)

SECONDARY SCHOOLS							
NUMBER OF TEACHERS WHO LEFT THE PROFESSION							
STATE/UNION TERRITORY	AT THE BEG- INNERS OF THE SESSION	RETIRED/ DIED	RESIGNED/ TERMINAT- ED	TRANS- FERED	TOTAL COL. 16 TO 18	PER- CENTAGE	
1	2	15	16	17	18	19	20
1	ANDHRA PRADESH	66497	758	167	460	1385	2.08
2	ARUNACHAL PRADESH	740	0	8	3	11	1.49
3	ASSAM	23967	26	9	4	39	0.16
4	BIHAR	41223	620	8	0	628	1.52
5	GOA	4888	12	50	3	65	1.33
6	GUJARAT	22321	220	348	72	640	2.87
7	HARYANA	37261	257	238	10	505	1.36
8	HIMACHAL PRADESH	8371	42	44	7	93	1.11
9	JAMMU & KASHMIR	13002	51	143	47	241	1.85
10	KARNATAKA	30101	81	49	30	160	0.53
11	KERALA	76808	526	135	184	845	1.10
12	MADHYA PRADESH	12600	44	118	97	259	2.06
13	MAHARASHTRA	108341	853	2509	327	3689	3.40
14	MANIPUR	4913	3	5	2	10	0.20
15	MEGHALAYA	3270	6	37	8	51	1.56
16	MIZORAM	1135	0	13	1	14	1.23
17	NAGALAND	1751	11	30	11	52	2.97
18	ORISSA	37779	108	123	9	240	0.64
19	PUNJAB	34956	243	41	213	497	1.42
20	RAJASTHAN	25611	82	155	138	375	1.46
21	SIKKIM	1260	3	20	5	28	2.22
22	TAMIL NADU	39132	513	49	152	714	1.82
23	TRIPURA	3535	12	2	28	42	1.19
24	UTTAR PRADESH	32076	1213	91	64	1368	4.26
25	WEST BENGAL	61103	331	123	15	469	0.77
26	A & N ISLANDS	504	0	2	0	2	0.40
27	CHANDIGARH	2285	10	55	2	67	2.93
28	DADRA & NAGAR HAVELI	39	0	6	0	6	15.38
29	DAMAN & DIU	260	0	2	0	2	0.77
30	DELHI	5972	21	42	3	66	1.11
31	LAKSHADWEEP	0	0	0	0	0	***.**
32	PONDICHERRY	0	0	0	0	0	***.**
	INDIA	701701	6046	4622	1895	12563	1.79

(CONTD..)

TABLE NO 4.9

Statewise Attrition Rates of Teachers - 1986(Concluded)

SR. S CONDARY SCHOOLS							
NUMBER OF TEACHERS WHO LEFT THE PROFESSION							
STATE/UNION TERRITORY	AT THE BEG- INNERS OF THE SESSION	RETIRED/ DIED	RESIGNED / TERMINAT- ED	TRANS- FERED	TOTAL COL. 16 TO 18	PER- CENTAGE	
1	2	21	22	23	24	25	26
1	ANDHRA PRADESH	12129	102	60	31	193	1.59
2	ARUNACHAL PRADESH	811	2	5	3	10	1.23
3	ASSAM	10835	12	3	2	17	0.16
4	BIHAR	6961	36	5	2	43	0.62
5	GOA	372	1	13	0	14	3.76
6	GUJARAT	24671	257	296	64	617	2.50
7	HARYANA	6011	40	61	2	103	1.71
8	HIMACHAL PRADESH	3152	11	2	5	18	0.57
9	JAMMU & KASHMIR	4877	22	9	42	73	1.50
10	KARNATAKA	15501	22	22	3	47	0.30
11	KERALA	3485	8	0	2	10	0.29
12	MADHYA PRADESH	31041	159	187	129	475	1.53
13	MAHARASHTRA	37092	251	490	29	770	2.08
14	MANIPUR	355	0	0	0	0	0.00
15	MEGHALAYA	61	0	0	0	0	0.00
16	MIZORAM	0	0	0	0	0	***. **
17	NAGALAND	0	0	0	0	0	***. **
18	ORISSA	667	1	2	0	3	0.45
19	PUNJAB	9626	60	13	49	122	1.27
20	RAJASTHAN	26395	59	162	82	303	1.15
21	SIKKIM	583	2	13	3	18	3.09
22	TAMIL NADU	63477	494	66	137	697	1.10
23	TRIPURA	3581	28	17	19	64	1.79
24	UTTAR PRADESH	79852	722	131	84	937	1.17
25	WEST BENGAL	29417	136	64	8	208	0.71
26	A & N ISLANDS	916	1	0	2	3	0.33
27	CHANDIGARH	599	5	11	1	17	2.84
28	DADRA & NAGAR HAVELI	87	0	0	0	0	0.00
29	DAHAN & DIU	37	0	0	0	0	0.00
30	DELHI	27767	208	328	23	559	2.01
31	LAKSHADWEEP	0	0	0	0	0	***. **
32	PONDICHERRY	0	0	0	0	0	***. **
	INDIA	400358	2639	1960	722	5321	1.33

CHAPTER - V

EXPENDITURE ON EDUCATION

TABLE NOs 5.1 TO 5.7

TABLE - 5.1

Total Expenditure on Education by Sources All India 1950-51 to 1989-90

(Figures in thousand in Rs.)

Year	Government Funds	Local Body Funds	University Funds	Fees	Endowment and Other Sources	Total
1	2	3	4	5	6	7
1950-51	652678	124987	N.A.	233272	132885	1143822
1960-61	2340914	224914	N.A.	590258	287714	3443800
1961-62	2718365	261906	N.A.	656069	327220	3963560
1962-63	3024765	296435	N.A.	737658	358619	4417477
1963-64	3344934	289710	N.A.	823577	382864	4841085
1964-65	3724499	312051	60631	885565	362327	5345073
1965-66	4374519	388733	63190	979356	414439	6220237
1966-67	4955648	384828	63761	1095016	479535	6978788
1967-68	5831116	447554	75517	1171533	587335	8113055
1968-69	6580391	431452	111247	1264863	595735	8983688
1969-70	7638760	375703	123973	1341672	623656	10103764
1970-71	8459499	484925	152162	1432370	653905	11182861
1971-72	9387190	N.A.	N.A.	N.A.	N.A.	1237480
1972-73	10511501	N.A.	N.A.	N.A.	N.A.	13737794
1973-74	12040932	655499	211713	1718341	823039	15449524
1974-75	12817687	N.A.	N.A.	N.A.	N.A.	18072865
1975-76	16523063	N.A.	N.A.	N.A.	N.A.	21047030
1976-77	17438122	1940979	254083	2280273	1189207	23102664
1977-78	20279633	1910772	312761	2417396	1182109	26102671
1978-79	23589380	1777830	409583	2571318	1294120	29642231
1979-80	26220951	1620829	425275	2825775	1368306	32461136
1980-81	30772393	1773291	514312	3090208	1516928	37667132
1981-82	35097051	2192798	698126	3443991	1765085	43197051
1982-83	40725864	2676401	838663	3874061	1996657	50111646
1983-84	46443305	3195042	916285	4273312	2153299	56981243
1984-85	53974960	3644171	2447876	4368611	3050020	67485638
1985-86	61121080	3974593	2877397	4775383	3369528	76117981
1986-87	73319777	4615806	3017624	5556998	3609618	90119823
1987-88	61831029	4882737	8384	2999134	2222331	71943615
1988-89	67663155	5474564	31500	4955019	3318865	81443103
1989-90	78657017	9317477	10975	3342663	2860381	94188513

TABLE - 5.2

Growth of Total Direct Expenditure by Type of Institutions-
All India-1950-51 to 1989-90

(Figures in thousands of Rs.)

Year	Primary Schools	Middle Schools	High/Higher Secondary Schools
1	2	3	4
1950-51	364843	76990	230450
1960-61	734461	429220	689117
1961-62	826691	488418	791185
1962-63	928935	555091	915418
1963-64	990089	613327	1055446
1964-65	1087130	718423	1173371
1965-66	1287231	642827	1376926
1966-67	1444559	965787	1613793
1967-68	1705502	1148096	1926187
1968-69	1862679	1319250	2179762
1969-70	2089720	1528669	2436275
1970-71	2345663	1709368	2700001
1971-72	2579875	1884691	3005661
1972-73	2898625	2104733	3316478
1973-74	3316858	2441963	3878611
1974-75	3848572	2926359	4369965
1975-76	4463148	3409672	4935622
1976-77	5374525	4069124	6193623
1977-78	5901932	4324089	6951441
1978-79	6549863	4707451	7671846
1979-80	7156249	5287051	8636327
1980-81	8384658	5478173	10121802
1981-82	9716133	6826234	12121665
1982-83	11319083	8030570	13585591
1983-84	12886963	9123632	16457858
1984-85	14561950	10279992	19166296
1985-86	16601096	11794059	21480869
1986-87	20084943	13984499	24691220
1987-88	21288380	15322338	27269484
1988-89	22753143	17377182	29120192
1989-90	26544317	20882956	32256774

TABLE NO. 5.3

Total Direct Expenditure by Type of Institutions for
General Education - States and Union Territories, 1980-81 and 1989-90

Sno.	State/Union Territories	Primary Schools		Middle Sr. Basic Schools		High/Post Basic Schools		Hr. Sec. Schools (10+2) including Intermediate colleges	
		1980-81	1989-90	1980-81	1989-90	1980-81	1989-90	1980-81	1989-90
1	2	3	4	5	6	7	8	9	10
		200178	540928	61951	160910		208826	495614	1294261
31	LAKSHADWEEP	2032	6966	2480	2455	3338	8695	1708	-
34	ANDHRA PRADESH	636591	2224934	294358	1089644	645269	2185110	193799	93864
2	ARUNACHAL PRADESH	17695	88617	12181	75699	9068	45085	5958	49559
3	ASSAM	296429	26944939	123518	20485904	6126610	338168	52126	269299
4	BIHAR	600865	2341337	469616	2226760	376548	1308870	13923	254123
5	GOA	33842	109334	5505	11608	52060	197985	4962	29227
6	GUJARAT	197900	679681	894172	3007773	221840	932117	339066	1434173
7	HARYANA	124835	469530	71279	689438	281806	1137841	50868	254929
8	HIMACHAL PRADESH	152532	593174	58809	229902	107352	410835	38746	244886
9	JAMMU & KASHMIR	60625	165580	78908	196795	90087	125435	27006	94450
10	KARNATAKA	257817	776077	76203	2073116	269470	927242	187252	780203
11	KERALA	369326	874375	327139	875383	684903	1854814	18666	644610
12	MADHYA PRADESH	733747	1995164	371419	787495	-	286700	379397	628105
13	MAHARASHTRA	742241	3094477	1066134	3711420	1095185	4177892	409519	2345105
14	MANIPUR	59628	198330	14138	153487	43885	156492	6159	47178
15	MEGHALAYA	20970	66732	8421	38322	17402	62002	-	12360
16	MIZORAM	16427	109389	13164	68216	11575	-	432	-
17	NAGALAND	32096	163048	20609	98181	17860	67446	-	6647
18	ORISSA	378599	1266560	183412	570511	228777	730095	1238	46224
19	PUNJAB	494755	1717826	108712	298164	429092	1335519	129231	588561
20	RAJASTHAN	341868	1019028	402865	1343124	211087	761329	179967	770306
21	SIKKIM	7933	81474	6604	35817	10134	47339	-	15781
22	TAMIL NADU	703265	1535984	403762	1108446	257027	790659	429472	1604474
23	TRIPURA	37393	265156	20636	112556	30553	154075	31735	192726
24	UTTAR PRADESH	1131565	3313098	337799	1011801	282055	769510	1023497	2849668
25	WEST BENGAL	711360	1808747	122124	359303	590029	133949	204882	611480
26	A & N ISLANDS	10644	27705	8347	28595	2309	18608	8753	43556
27	CHANDIGARH	640	9538	2308	7065	9243	73939	4237	40097
28	DADRA & NAGAR HAVELI	1474	5056	2197	11073	808	1971	577	5319
29	DAMAN & DIU	*	7497	*	7499	*	9994	*	448
30	DELHI	200178	540928	61951	160910	-	208826	495614	1294261
31	LAKSHADWEEP	2032	6966	2480	2455	3338	8695	1708	-
32	PONDICHERY	9386	46038	9423	45966	18405	39541	1756	27631
INDIA		8384658	26544317	5478173	20882956	6128777	20571841	4240544	14209988

* Figures are included in Goa

TABLE - 5.4

Percentage of Educational Expenditure on Education Department to Total Budget (Revenue Account), 1967-68 to 1993-94

Year	State/UTs.	Centres	Total
1967-68	19.8	1.6	11.9
1968-69	20.2	2.0	12.6
1969-70	20.5	2.4	13.1
1970-71	21.4	2.6	13.9
1971-72	20.3	2.2	12.8
1972-73	20.1	2.4	12.7
1973-74	20.6	2.0	13.1
1974-75	23.2	2.2	14.1
1975-76	22.7	2.1	13.6
1976-77	22.0	2.1	13.1
1977-78	22.7	2.1	13.4
1978-79	21.7	2.1	13.1
1979-80	21.8	1.8	12.7
1980-81	20.6	1.6	11.6
1981-82	20.0	1.5	11.3
1982-83	21.3	1.3	10.8
1983-84	20.8	1.5	11.4
1984-85	20.5	1.6	11.2
1985-86	20.1	1.5	10.8
1986-87	NA	NA	NA
1987-88	NA	NA	NA
1988-89	NA	NA	NA
1989-90	11.9	2.3	11.9
1990-91	21.2	2.2	11.7
1991-92	19.4	2.1	11.0
1992-93 (R. E)	19.6	1.9	11.1
1993-94 (BE)	20.4	2.1	11.5

TABLE NO. 5.5

State-wise Total & Budgeted Expenditure on Education & Training
and other Departments (Revenue Account), 1991-92 to 1993-94

Sno.	State/Union Territories	1991 -92(Actual)			1992 - 93 (Actual)			1993 - 94 (Revised)		
		Total State Budget	Exp. on Education & Trg.	% of Col.4 to 3	Total State Budget	Exp. on Education & Trg.	% of Col.7 to 6	Total State Budget	Exp. on Education & Trg.	% of Col.10 to 9
1	2	3	4	5	6	7	8	9	10	11
1	ANDHRA PRADESH	64515600	11234600	17.4	71901715	17482653	24.3	79246600	16611500	20.9
2	ARUNACHAL PRADESH	2914800	445700	15.2	3401300	538045	15.8	4987500	579800	11.6
3	ASSAM	21481000	5317800	24.7	24509278	7137282	29.1	27745000	6827500	24.6
4	BIHAR	43522500	12605300	28.9	65695520	15263763	23.2	72661800	14602200	20.1
5	GOA	3317500	701500	21.1	3803100	879311	23.1	4295800	839200	19.5
6	GUJARAT	52382000	10406900	19.8	62109000	12836832	20.6	59477200	12371100	20.8
7	HARYANA	22740200	3540900	15.5	23793409	5005521	21.0	28293200	4555800	16.1
8	HIMACHAL PRADESH	10723200	1961500	18.2	11455700	2505477	21.8	13938100	2949500	21.1
9	JAMMU & KASHMIR	12190500	1381000	11.3	12190500	1687810	13.8	12190500	1381000	11.3
10	KARNATAKA	49541200	9341600	18.8	55916851	11862432	21.2	65884900	14095100	21.3
11	KERALA	32164600	8213400	25.5	36561341	10252885	28.0	43067600	11306900	26.2
12	MADHYA PRADESH	54208200	9781400	18.0	61573088	14880238	24.1	65950300	12029800	18.2
13	MAHARASHTRA	100487200	20546400	20.4	115467014	25540067	22.1	125006400	22304500	17.8
14	MANIPUR	3774900	852300	22.5	3641069	1125680	30.9	3888400	935000	24.0
15	MEGHALAYA	3680500	675000	18.3	4102918	811050	19.7	5165900	910800	17.6
16	MIZORAM	3210700	488600	15.2	3741039	647243	17.3	3648800	551800	15.1
17	NAGALAND	4888000	494700	10.1	5271298	692594	13.1	5013000	599900	11.9
18	ORISSA	26350200	5383000	20.4	30488806	7184024	23.5	36260000	7182600	19.8
19	PUNJAB	41967100	5533100	13.1	34225216	6439772	18.8	40011200	6869200	17.1
20	RAJASTHAN	40802300	8670500	21.2	49969660	11561550	23.1	54047000	11293800	20.9
21	SIKKIM	1550900	267200	17.2	1849036	340764	18.4	1864200	316200	16.9
22	TAMIL MADU	86795200	14309400	16.4	85425233	17863831	20.9	83008800	17708700	21.3
23	TRIPURA	5476500	1155400	21.1	5501284	1431556	26.0	6628400	1336800	20.1
24	UTTAR PRADESH	103992000	19849500	19.0	126907360	27838861	21.9	131728000	24745900	18.7
25	WEST BENGAL	55699800	13046900	23.4	56637029	14586717	25.7	71959700	19331000	26.8
26	A & N ISLANDS	1970000	210300	10.6	1901414	250727	13.1	2061600	248400	12.0
27	CHANDIGARH	2236500	436900	19.5	2466551	532279	21.5	2614700	528900	20.2
28	DADRA & NAGAR HAVELI	271000	37200	13.7	358014	45071	12.5	429600	50600	11.7
29	DAMAN & DIU	241100	46400	19.2	262045	57338	21.8	323400	52600	16.2
30	DELHI	10483300	3060800	29.2	11803000	3770941	31.9	13084400	3868900	29.5
31	LAKSHADWEEP	419800	53500	12.7	605967	71131	11.7	780900	86400	11.0
32	PONDICHERRY	2401100	386800	16.1	2720144	537799	19.7	2967000	458100	15.4
INDIA		880623800	170435400	19.3	976254919	221761244	22.7	106822990	217529500	203.6

State-wise Total & Budgeted Expenditure on Education, on selected items - States/UTs, 1991-92 to 1993-94

Sno.	State/Union Territories	Elementary Education				High/Higher/Secondary Education							
		1991-92 (Actual)	Per Centage	1992-93 (Revised Estimates)	Per-Centage	1993-94 (Budget Estimates)	Per centage	1991-92 (Actual)	Per Centage	1992-93 (Revised Estimates)	Per-Centage	1993-94 (Budget Estimates)	Per-centage)
1	2	3	4	5	6	7	8	9	10	11	12	13	14
1	ANDHRA PRADESH	4999500 (44.5)		6055288 (44.7)		6521083 (39.00)		3303213 (29.4)		3867320 (28.5)		4134295 (24.9)	
2	ARUNACHAL PRADESH	294657 (66.1)		321868 (63.5)		372993 (64.0)		86015 (19.3)		107391 (21.2)		128270 (22.1)	
3	ASSAM	3092308 (58.2)		3543845 (52.1)		4018614 (58.0)		1303327 (28.3)		1832998 (27.00)		1793038 (26.3)	
4	BIHAR	7910978 (62.8)		8471242 (64.0)		9491700 (65.0)		2495445 (19.8)		2637435 (19.9)		2817894 (19.3)	
5	GOA	196371 (27.9)		228672 (27.8)		239040 (27.8)		358602 (51.1)		410455 (49.9)		418330 (49.8)	
6	GUJARAT	5418388 (52.1)		5618736 (51.1)		6906106 (55.0)		3539575 (34.0)		3606155 (32.7)		3784010 (30.6)	
7	HARYANA	1573967 (44.5)		1933791 (44.9)		2022171 (44.0)		1302032 (36.8)		1519285 (35.3)		1382428 (34.7)	
8	HIMACHAL PRADESH	1013116 (51.7)		1229265 (53.9)		1646703 (44.0)		716015 (36.5)		763625 (33.5)		1005812 (34.1)	
9	JAMMU & KASHMIR	617385 (44.7)		617385 (44.7)		617385 (55.0)		519216 (37.6)		519216 (37.6)		519216 (37.6)	
10	KARNATAKA	4683574 (50.1)		5987964 (52.0)		7537163 (53.0)		2726175 (29.2)		3446863 (29.9)		3989077 (28.3)	
11	KERALA	4097140 (49.9)		4583919 (47.8)		5365983 (47.0)		2432757 (29.6)		2956178 (30.8)		3506761 (31.0)	
12	MADHYA PRADESH	5911252 (60.4)		7155543 (63.9)		7521053 (62.0)		2305604 (23.6)		2138321 (19.1)		2455324 (20.4)	
13	MAHARASHTRA	8868596 (43.2)		10146589 (44.0)		9883794 (44.0)		8112075 (39.5)		8909382 (38.6)		8594516 (38.5)	
14	MANIPUR	347688 (40.8)		410727 (42.9)		406830 (43.0)		280642 (32.9)		316182 (33.1)		312249 (33.4)	
15	MEGHALAYA	399450 (59.2)		441162 (59.8)		553381 (60.0)		178773 (26.7)		206533 (26.8)		219940 (24.2)	
16	MIZORAM	278596 (57.0)		312618 (56.1)		311153 (56.1)		108061 (22.1)		123110 (22.1)		126362 (22.9)	
17	NAGALAND	297094 (60.1)		345206 (61.3)		377893 (62.0)		121860 (24.6)		132051 (23.5)		132880 (22.2)	
18	ORISSA	3130757 (58.2)		4180689 (59.9)		4081772 (56.0)		1173872 (21.8)		1557907 (22.3)		1560749 (21.7)	
19	PUNJAB	1685158 (30.5)		2100769 (31.9)		2377984 (34.0)		2840712 (51.3)		3344886 (50.8)		3321343 (48.4)	
20	RAJASTHAN	4531019 (52.3)		5253520 (52.1)		5885014 (52.0)		2990387 (34.5)		3440095 (34.1)		3806879 (33.7)	
21	SIKKIM	152560 (57.1)		174820 (58.0)		176240 (55.0)		93845 (35.1)		110170 (36.6)		124660 (39.4)	
22	TAMIL NADU	7353349 (51.4)		7382704 (47.6)		8847491 (49.0)		4910677 (34.3)		5136899 (33.2)		5980577 (33.8)	
23	TRIPURA	500136 (43.3)		544100 (41.4)		550120 (41.0)		486468 (42.1)		589166 (44.8)		594804 (44.5)	
24	UTTAR PRADESH	10659083 (53.7)		12146874 (53.6)		13335881 (53.0)		6781215 (34.2)		7670166 (33.8)		8034283 (32.5)	
25	WEST BENGAL	4823702 (36.9)		5040510 (33.3)		543692 (28.0)		6227949 (47.7)		6896927 (45.5)		7698531 (39.8)	
26	A & N ISLANDS	119326 (56.7)		140019 (57.6)		142903 (57.0)		63477 (30.2)		66150 (27.2)		66206 (26.6)	
27	CHANDIGARH	87280 (19.9)		84400 (18.1)		96572 (18.0)		64886 (14.8)		76212 (15.9)		92525 (17.5)	
28	DADRA & NAGAR HAVELI	26071 (70.1)		26277 (64.9)		32196 (63.0)		8818 (23.7)		10113 (24.9)		12072 (28.9)	
29	DAMAN & DIU	21199 (45.7)		21673 (43.4)		23560 (44.0)		13057 (28.1)		15337 (30.7)		16585 (38.5)	
30	DELHI	747116 (24.4)		835846 (23.5)		914977 (23.0)		2037939 (66.6)		2329268 (65.5)		2510564 (64.9)	
31	LAKSHADWEEP	26308 (49.1)		31122 (46.7)		37944 (43.0)		16877 (31.5)		22415 (33.6)		31844 (36.8)	
32	PONDICHERY	151100 (39.1)		169757 (40.3)		189548 (41.0)		114460 (29.6)		128791 (30.6)		147916 (32.3)	
	INDIA	84614224 (49.29)		95558900 (48.88)		105922168 (48.69)		57914026 (34.0)		60050047 (33.2)		69519940 (32.0)	

- 70 -
TABLE NO. 5.6

State-wise Total & Budgeted Expenditure on Education, on selected items -
States/UTs, 1991-92 to 1993-94

Sno.	State/Union Territories	Adult Education					
		1991-92 (Actual)	Per Centage	1992-93 (Revised Estimates)	Per- Centage	1993-94 (Budget Estimates)	Per- centage
1	2	15	16	17	18	19	20
1	ANDHRA PRADESH	68622	(0.6)	123545	(0.6)	125741	(0.8)
2	ARUNACHAL PRADESH	14651	(3.3)	10431	(2.1)	11183	(0.6)
3	ASSAM	73033	(1.4)	41744	(0.6)	44348	(0.6)
4	BIHAR	127524	(1.0)	79319	(0.6)	84411	(0.5)
5	GOA	5805	(0.8)	9172	(1.1)	7125	(0.8)
6	GUJARAT	52424	(0.5)	64426	(0.6)	64526	(0.5)
7	HARYANA	6318	(0.2)	59855	(1.4)	11882	(0.3)
8	HIMACHAL PRADESH	6767	(0.3)	24744	(1.1)	9370	(0.3)
9	JAMMU & KASHMIR	21850	(1.6)	21856	(1.6)	21850	(1.6)
10	KARNATAKA	67568	(0.7)	81057	(0.7)	99657	(0.7)
11	KERALA	3284	(0.1)	6282	(0.1)	6307	(0.1)
12	MADHYA PRADESH	121379	(1.2)	110412	(1.0)	126647	(1.0)
13	MAHARASHTRA	157737	(0.8)	137723	(0.6)	98545	(0.4)
14	MANIPUR	10755	(1.3)	8895	(0.9)	7692	(0.8)
15	MEGHALAYA	11247	(1.7)	16763	(2.2)	24237	(2.7)
16	MIZORAM	6633	(1.4)	9741	(1.8)	11058	(2.0)
17	NAGALAND	9165	(1.8)	10190	(1.8)	5708	(0.9)
18	ORISSA	36434	(0.7)	77695	(1.1)	60309	(0.8)
19	PUNJAB	4469	(0.1)				
20	RAJASTHAN	68345	(0.8)	42655	(0.4)	33062	(0.3)
21	SIKKIM	7900	(2.9)	3400	(1.3)	3300	(1.0)
22	TAMIL NADU	93932	(0.7)	76563	(0.5)	256462	(1.4)
23	TRIPURA	68015	(5.9)	69420	(5.3)	73419	(5.6)
24	UTTAR PRADESH	125491	(0.6)	88243	(0.4)	71584	(0.3)
25	WEST BENGAL	59656	(0.5)	107140	(0.7)	134130	(0.7)
26	A & N ISLANDS	1045	(0.5)	1262	(0.5)	1278	(0.5)
27	CHANDIGARH	655	(0.2)	1750	(0.4)	650	(0.1)
28	DADRA & NAGAR HAVELI	180	(0.5)	250	(0.6)	349	(0.7)
29	DAMAN & DIU	332	(0.7)	285	(0.6)	345	(0.7)
30	DELHI	11669	(0.4)	24701	(0.7)	46794	(1.2)
31	LAKSHADWEEP	360	(0.7)	626	(0.9)	866	(1.0)
32	PONDICHERY	2047	(0.5)	728	(0.2)	1030	(0.2)
	INDIA	1245312	(0.7)	1310867	(0.7)	1445865	(0.7)

TABLE NO. 5.7

Percentage of Budgeted Expenditure on Education of Education Department to the Total Budget (Revenue Account) State/UTs during 1989-90 to 1993-94

Sno.	State/Union Territories	1989-90 (Actuals)	1990-91 (Actuals)	1991-92 (Actuals)	1992-93 (Actuals)	1993-94 (Actuals)
1	2	3	4	5	6	7
1	ANDHRA PRADESH	21.2	18.0	17.4	19.0	21.0
2	ARUNACHAL PRADESH	12.8	14.3	15.3	14.9	11.6
3	ASSAM	22.4	22.9	24.8	26.8	24.6
4	BIHAR	27.2	24.5	22.0	20.1	20.1
5	GOA	22.9	24.0	21.1	21.1	19.5
6	GUJARAT	20.4	21.8	19.9	17.8	20.8
7	HARYANA	17.3	16.4	15.6	17.3	16.1
8	HIMACHAL PRADESH	20.1	18.7	18.3	18.6	21.2
9	JAMMU & KASHMIR	14.8	14.8	11.3	11.3	11.3
10	KARNATAKA	20.1	19.7	18.9	19.7	21.4
11	KERALA	27.1	26.9	25.5	24.9	26.3
12	MADHYA PRADESH	18.8	18.4	18.0	18.2	18.2
13	MAHARASHTRA	19.6	19.5	20.4	20.1	17.8
14	MANIPUR	18.7	18.7	22.6	26.3	24.1
15	MEGHALAYA	19.8	18.0	18.3	17.8	17.6
16	MIZORAM	13.7	13.3	15.2	14.8	15.1
17	NAGALAND	10.4	11.1	10.1	10.7	12.0
18	ORISSA	22.1	0.6	20.4	20.9	19.8
19	PUNJAB	25.2	19.9	13.2	19.8	17.2
20	RAJASTHAN	24.3	22.9	21.2	20.3	20.9
21	SIKKIM	18.9	18.6	17.2	16.3	17.0
22	TAMIL NADU	22.1	22.4	16.5	20.2	21.3
23	TRIPURA	21.8	20.6	21.1	22.2	20.2
24	UTTAR PRADESH	24.0	21.8	19.1	19.3	18.8
25	WEST BENGAL	23.0	26.4	23.4	23.4	26.9
26	A & N ISLANDS	10.7	23.1	10.7	12.2	12.1
27	CHANDIGARH	20.3	21.9	19.5	19.5	20.2
28	DADRA & NAGAR HAVELI	11.9	12.0	13.7	11.1	11.8
29	DAMAN & DIU	24.3	19.7	19.3	19.0	16.3
30	DELHI	27.7	28.4	28.2	30.1	29.6
31	LAKSHADWEEP	12.2	11.8	12.7	10.9	11.1
32	PONDICHEERY	17.3	16.8	16.1	15.3	15.4
	INDIA	21.9	19.7	19.3	19.0	16.3

CHAPTER - VI

SCHOOL TEACHERS

TABLE NOs 6.1 TO 6.5

DISTRIBUTION OF TEACHERS PRIMARY SCHOOLS

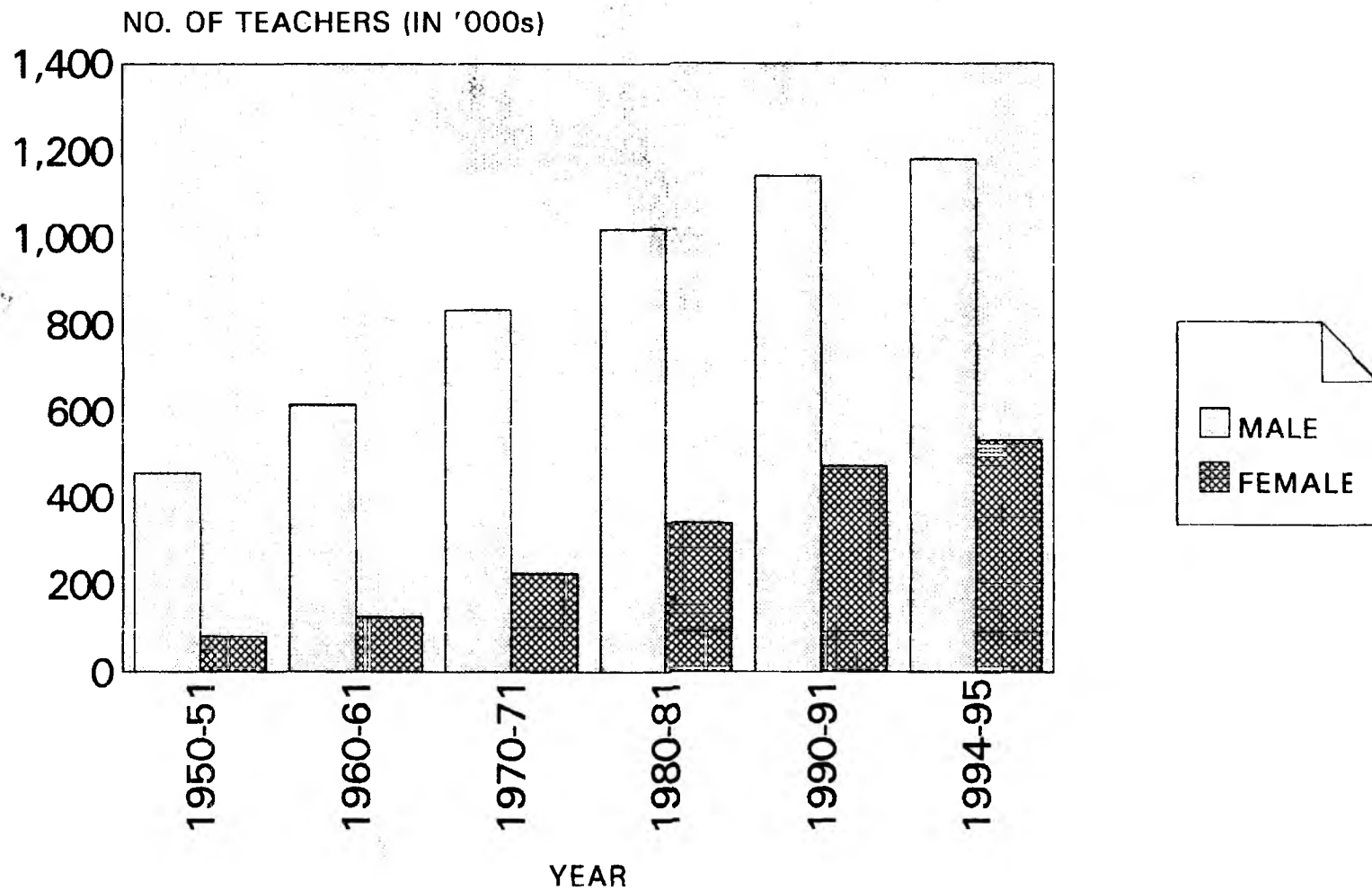

DISTRIBUTION OF TEACHERS MIDDLE SCHOOLS

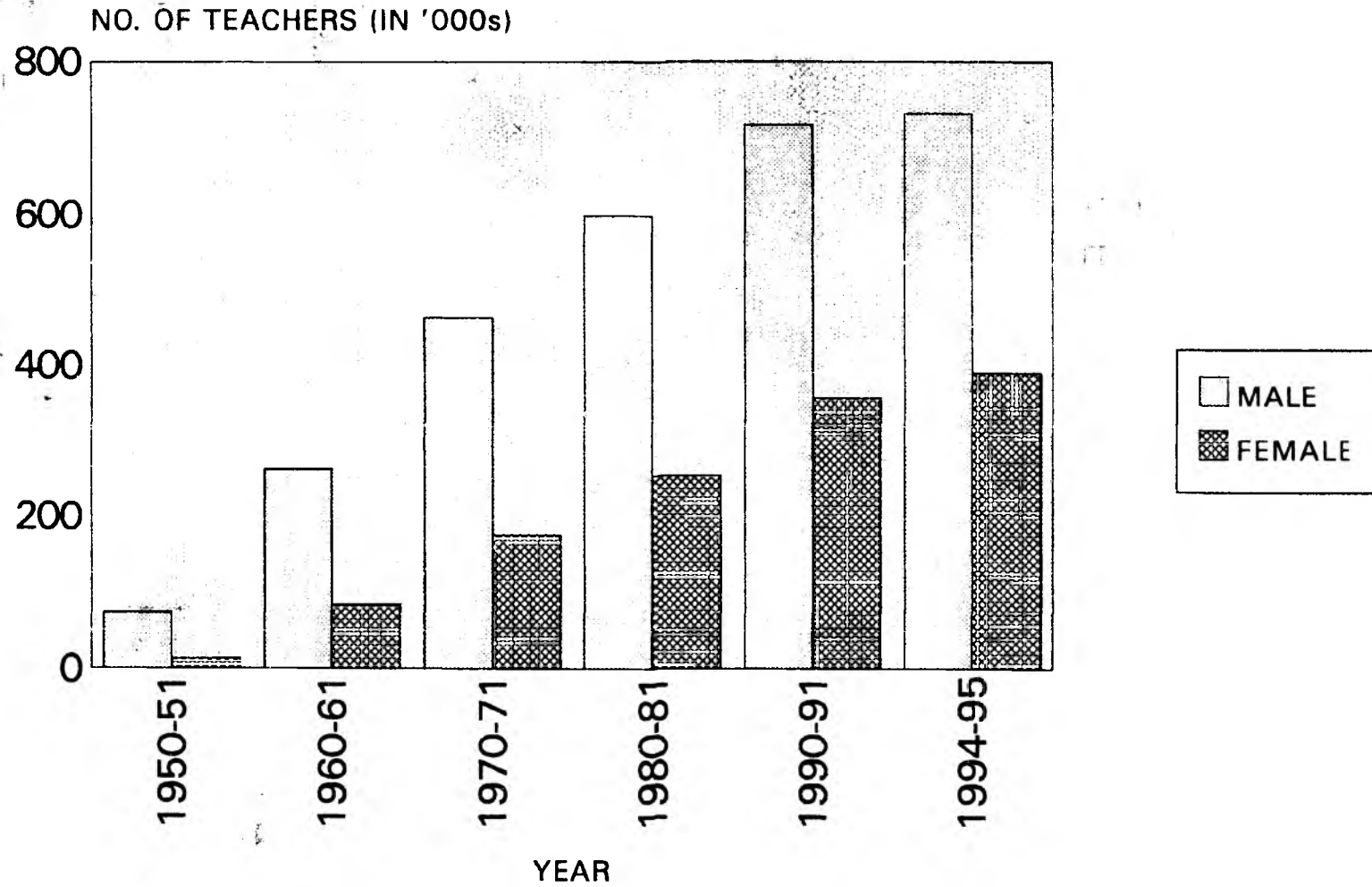

TABLE - 6.1

Growth of School Teachers in India - 1950-51 to 1994-95

Year	Primary Schools		Middle Schools		High/Hr.Sec. Schools		Total	
	Men	Women	Men	Women	Men	Women	Men	Women
1	2	3	4	5	6	7	8	9
1950-51	455637	82281	72609	12887	106522	19982	634768	115150
1960-61	614727	126788	261696	83532	233958	62347	1110381	272667
1961-62	655955	138820	287795	94251	259289	71281	1203039	304352
1962-63	685623	147373	314050	108243	287952	79826	1287625	335442
1963-64	721847	159591	333072	117331	312593	89011	1367512	365933
1964-65	738541	172896	362916	129588	341376	100476	1442833	402960
1965-66	764062	180315	389225	138529	368357	110703	1521644	429547
1966-67	785482	193037	407127	148442	402467	122152	1595076	463631
1967-68	797065	201249	418763	151251	427257	132349	1643085	484849
1968-69	800009	205273	435061	160672	442355	139263	1677425	505208
1969-70	817576	292964	449133	165967	458545	147248	1725254	526179
1970-71	835340	224610	463063	174506	473776	155424	1772179	554540
1971-72	863955	234040	479399	186258	492395	165551	1835749	585849
1972-73	902558	248247	499467	192796	510865	174000	1912890	615043
1973-74	927592	268303	520118	207985	556386	193029	2004096	669317
1974-75	955623	275999	541595	216615	546289	193352	2043507	685966
1975-76	964311	283242	554043	223885	558567	199994	2076921	707121
1976-77	968057	290521	562370	231025	565156	208904	2095583	730450
1977-78	968460	298733	569084	237149	579035	219075	2116579	754957
1978-79	968492	328147	579727	245479	599217	219290	2147436	792856
1979-80	997611	331089	587248	248360	631547	238295	2216406	817744
1980-81	1021275	341942	598191	253326	657839	254290	2277305	849568
1981-82	1093198	350488	601363	362091	686329	272346	2330890	884925
1982-83	1062962	360677	611396	271110	720459	290992	2394817	922779
1983-84	1073224	371358	616058	278727	740026	806278	2429308	956363
1984-85	1097893	387412	634699	292924	765071	821518	2497663	1001854
1985-86	1094168	401644	663208	305140	792703	338802	2550079	1045586
1986-87	1091502	419660	675783	320888	806222	350966	2573507	1091514
1987-88	1100802	442042	695971	334518	835658	367353	2632431	1143913
1988-89	1106751	446828	699184	339608	847470	378619	2653405	1165055
1989-90	1114427	450476	701825	344750	864900	393144	2681152	1196370
1990-91	1143514	472506	716431	356480	917301	417444	2777246	1246430
1991-92(P)	1194080	498934	717878	353731	880013	429786	2791971	1282451
1992-93(P)	1189004	492966	736362	345983	907184	395764	2826450	1234713
1993-94(P)	1196251	506913	710069	369519	937466	467235	2843786	1393667
1994-95(P)	1181278	533117	732187	390249	955884	489812	2869349	1413178

(P) The data is provisional

DISTRIBUTION OF TEACHERS HIGH/Hr. SEC.

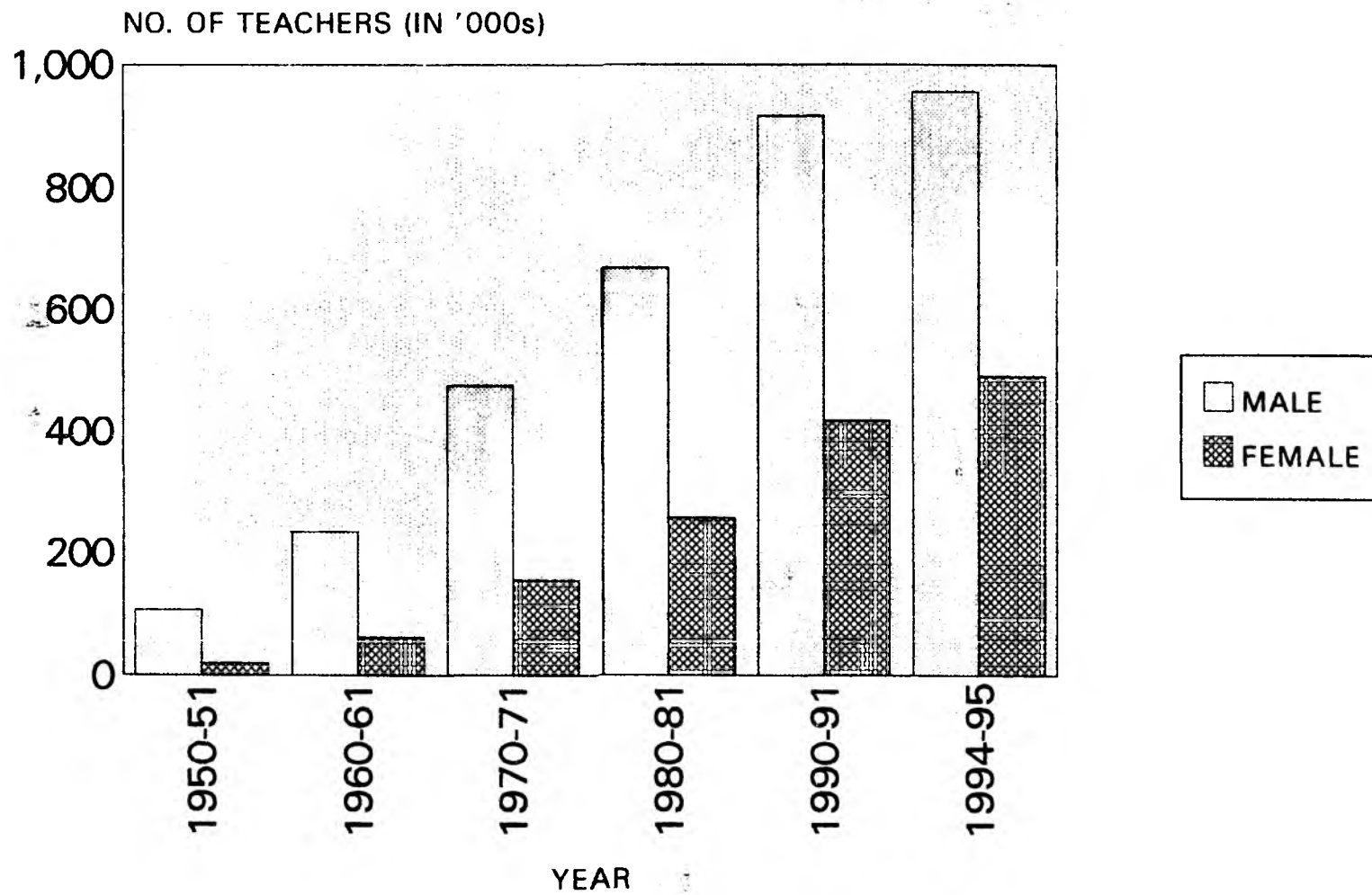

TABLE NO. 6.2

Number of Teachers (Trained and Total) in Primary Schools in States/UTs - 1980-81 & 1990-91

Sno.	State/Union Territories	1980 - 81				1990 - 91			
		Total		Trained		Total		Trained	
		Men	Women	Men	Women	Men	Women	Men	Women
1	2	3	4	5	6	7	8	9	10
1	ANDHRA PRADESH	59461	21492	58849	21162	79219	31638	76816	31074
2	ARUNACHAL PRADESH	1257	181	590	55	1896	470	1355	316
3	ASSAM	37682	9460	26349	5820	47412	15961	32394	9122
4	BIHAR	94169	17003	88398	15002	43222	23172	87908	81505
5	GOA	1480	1403	1381	1245	1123	1789	449	476
6	GUJARAT	15314	7787	15072	7231	19305	12707	19106	12211
7	HARYANA	10493	4587	10488	4586	12194	8177	12192	8165
8	HIMACHAL PRADESH	9873	4851	9810	4815	11830	6950	10864	6597
9	JAMMU & KASHMIR	6482	4177	4815	3214	9835	6605	6563	4679
10	KARNATAKA	27402	6661	24272	5647	30869	13734	29067	13103
11	KERALA	24349	28100	23325	27662	18706	31738	17542	31266
12	MADHYA PRADESH	96348	21523	83192	17151	139275	41577	95387	23675
13	MAHARASHTRA	67056	34029	59886	30474	72749	47278	67435	44680
14	MANIPUR	8097	1098	5283	613	8431	2575	4988	1025
15	MEGHALAYA	3985	2313	1777	1023	4127	2491	1819	1114
16	MIZORAM	1494	909	973	419	2058	1689	1592	1279
17	NAGALAND	4044	1429	1778	457	4531	1701	2369	796
18	ORISSA	73349	7570	58077	5645	72263	19400	68649	18631
19	PUNJAB	22665	25237	22631	25016	21934	26041	21882	25678
20	RAJASTHAN	37251	10394	35603	7346	57893	18784	52944	14575
21	SIKKIM	855	251	436	83	1600	637	862	343
22	TAMIL NADU	69574	43214	69574	43214	71336	48585	71336	48580
23	TRIPURA	3534	1170	2122	948	7102	1924	1880	757
24	UTTAR PRADESH	203712	44042	199305	41324	209120	57037	202889	51230
25	WEST BENGAL	132488	32990	70961	16117	136262	36222	74944	19922
26	A & N ISLANDS	482	232	463	205	473	251	462	236
27	CHANDIGARH	70	400	70	400	78	686	78	686
28	DADRA & NAGAR HAVELI	118	41	108	41	110	50	99	49
29	DAMAN & DIU	a	a	a	a	119	169	108	144
30	DELHI	7296	8975	7296	8975	7190	11538	7187	11478
31	LAKSHADWEEP	92	38	80	29	158	73	157	73
32	PONDICHEERY	804	385	804	385	1086	849	1080	728
	INDIA	1021275	341942	883768	296304	1143514	472506	972386	405192

a Included in Goa as Daman & Diu was integrated part of Goa in the year 1980

TABLE NO. 6.3

Number of Teachers (Trained and total) in Middle School in States/UTs - 1980-81 & 1990-91

Sno.	State/Union Territories	1 9 8 0 - 8 1				1 9 9 0 - 9 1			
		Total		Trained		Total		Trained	
		Men	Women	Men	Women	Men	Women	Men	Women
		3	4	5	6	7	8	9	10
1	ANDHRA PRADESH	24928	10496	24441	10123	28270	13567	27701	13245
2	ARUNACHAL PRADESH	706	103	320	41	1355	316	521	79
3	ASSAM	20504	3560	6100	1111	28171	6269	7687	2031
4	BIHAR	69892	13607	66049	12533	80465	19795	76354	18632
5	GOA	650	512	602	446	449	476	413	463
6	GUJARAT	63134	43687	61890	41453	74463	61508	73137	60085
7	HARYANA	5882	2851	5876	2835	7382	4797	7316	4722
8	HIMACHAL PRADESH	4429	886	4376	883	4668	1098	4637	1069
9	JAMMU & KASHMIR	8779	4449	7255	3322	11515	6484	8258	4178
10	KARNATAKA	51674	25103	46203	22783	58133	37794	56075	35828
11	KERALA	24276	25352	22944	24999	19693	31083	18036	29242
12	MADHYA PRADESH	44536	11728	38630	9019	62091	20772	44983	12421
13	MAHARASHTRA	85385	35600	79344	32313	92738	55557	88019	52671
14	MANIPUR	2714	445	1304	178	4978	1745	1522	341
15	MEGHALAYA	1317	651	243	155	1950	1111	344	233
16	MIZORAM	1418	260	515	106	2626	636	1787	687
17	NAGALAND	2271	561	575	109	2807	791	841	213
18	ORISSA	27991	2732	16739	2242	32644	5948	27094	5591
19	PUNJAB	6067	4359	6053	4281	5147	4071	5127	3906
20	RAJASTHAN	34457	9020	33628	8072	54005	19488	50483	15145
21	SIKKIM	355	117	184	66	1078	487	460	201
22	TAMIL NADU	36647	32859	36647	32859	33879	31676	33879	31676
23	TRIPURA	2331	773	1428	441	3250	954	965	325
24	UTTAR PRADESH	58775	14326	55602	13478	79914	19415	74035	17417
25	WEST BENGAL	15969	4788	8786	2706	20820	5171	12284	3051
26	A & N ISLANDS	346	279	324	263	351	349	343	338
27	CHANDIGARH	43	299	43	299	85	506	85	506
28	DADRA & NAGAR HAVELI	114	109	108	104	169	215	159	200
29	DAMAN & DIU	a	a	a	a	139	91	133	90
30	DELHI	1692	2373	1682	2298	2068	3530	2051	3446
31	LAKSHADWEEP	44	27	38	21	73	51	73	51
32	PONDICHERY	865	424	865	424	1063	729	1054	687
	INDIA	598191	253346	528794	229963	716431	356480	625856	318471

a Included in Goa as there was no separate Union Territory of Daman & Diu in 1980-81.

TABLE NO. 6.4

Number of Teachers (Trained and total) in High/Higher Secondary in States/UTs - 1980-81 & 1990-91

Sno.	State/Union Territories	1 9 8 0 - 8 1				1 9 9 0 - 9 1			
		Total		Trained		Total		Trained	
		Men	Women	Men	Women	Men	Women	Men	Women
1	2	3	4	5	6	7	8	9	10
1	ANDHRA PRADESH	45207	15210	44192	14695	52584	24733	52339	24439
2	ARUNACHAL PRADESH	650	97	371	41	1788	385	900	139
3	ASSAM	21272	3826	5627	902	37584	10269	10315	2583
4	BIHAR	33314	3759	30487	3452	41037	6791	39566	6424
5	GOA	2430	2275	1923	1568	3185	3834	2742	3224
6	GUJARAT	30777	7659	13038	7279	43877	14080	43501	13965
7	HARYANA	21938	9887	21847	9781	28203	18042	28110	17960
8	HIMACHAL PRADESH	6291	2304	6167	2220	10157	4115	10055	3984
9	JAMMU & KASHMI	10010	4858	8007	3546	14928	6622	11129	4903
10	KARNATAKA	24169	6450	21221	5700	44020	15216	92488	14674
11	KERALA	33719	39803	33205	39096	35848	57275	35506	56656
12	MADHYA PRADESH	26814	7631	22057	6523	43133	14134	32550	10626
13	MAHARASHTRA	81842	32223	77094	30771	126324	55518	120486	53082
14	MANIPUR	3009	641	1273	146	5230	2540	1946	607
15	MEGHALAYA	1176	924	267	324	1819	1541	439	605
16	MIZORAM	747	113	173	42	1244	242	584	126
17	NAGALAND	1219	477	409	114	2110	1012	747	300
18	ORISSA	22207	4000	15496	3259	34588	7050	27364	6133
19	PUNJAB	23746	15498	23616	15349	27519	23181	27394	22828
20	RAJASTHAN	32472	7356	31668	6919	52197	16032	50642	14313
21	SIKKIM	542	379	240	148	1243	838	535	355
22	TAMIL NADU	55734	30536	54898	29344	67801	47580	67553	46584
23	TRIPURA	3648	1350	2274	959	7514	3090	3251	1433
24	UTTAR PRADESH	96117	19747	91246	18569	106650	19522	100851	18658
25	WEST BENGAL	64702	21371	41707	14425	86728	29714	63303	21625
26	A & N ISLANDS	430	243	415	226	1179	931	1155	915
27	CHANDIGARH	462	1120	462	1120	886	2033	886	2033
28	DADRA & NAGAR HAVELI	58	9	55	8	109	44	103	44
29	DAMAN & DIU	a	a	a	a	166	57	159	54
30	DELHI	11536	13881	11179	13487	17209	24886	17017	24463
31	LAKSHADWEEP	177	54	160	53	244	65	239	65
32	PONDICHEERY	1364	609	1364	609	1703	1185	1689	1144
	INDIA	657839	254290	578762	230675	898807	412757	795604	375144

a Included in Goa as it was Union Territory of Gos, Daman & Diu in 1980-81

TABLE NO. 6.5

Percentage of Trained Teachers to Total Number of Teachers by Type of Institutions - 1980-81 & 1990-91

Sno.	State/Union	1980 - 81						1990 - 91					
		Primary School		Middle School		High/Higher Sec School		Primary School		Middle School		High/Higher Sec School	
		Men	Women	Men	Women	Men	Women	Men	Women	Men	Women	Men	Women
1	2	3	4	5	6	7	8	9	10	11	12	13	14
1	ANDHRA PRADESH	99.50	98.50	98.90	96.40	97.80	96.60	96.97	98.22	97.99	97.63	99.53	98.81
2	ARUNACHAL PRADESH	46.90	30.40	45.30	39.80	57.10	42.30	35.97	34.28	38.45	25.00	50.33	36.10
3	ASSAM	70.10	61.50	29.80	31.20	26.50	23.60	68.32	57.15	27.29	32.40	27.44	25.15
4	BIHAR	93.90	88.20	94.50	92.10	91.50	91.80	94.30	92.81	74.89	74.12	96.42	94.60
5	GOA	93.30	88.70	92.60	87.10	78.90	69.20	85.04	91.62	91.98	97.27	98.88	84.08
6	GUJARAT	98.40	92.10	98.00	94.90	42.40	95.00	98.92	96.10	98.22	97.69	99.14	99.18
7	HARYANA	100.00	100.00	99.90	99.40	99.60	98.90	99.98	99.85	99.11	98.44	99.67	99.55
8	HIMACHAL PRADESH	99.40	99.30	98.80	99.70	98.00	94.60	91.00	94.92	99.51	97.36	98.99	96.82
9	JAMMU & KASHMIR	74.30	77.10	82.60	74.70	80.00	73.00	66.73	70.84	71.72	64.31	74.55	43.88
10	KARNATAKA	88.60	85.10	89.40	91.10	87.80	88.40	94.16	95.41	96.46	94.80	96.52	96.44
11	KERALA	95.80	98.40	94.50	94.90	98.50	98.20	93.78	98.51	91.59	94.08	99.04	98.91
12	MADHYA PRADESH	86.30	79.70	86.70	76.90	82.30	85.50	68.49	56.94	72.45	59.00	75.46	75.18
13	MAHARASHTRA	89.30	84.60	92.90	90.80	94.20	95.50	92.78	94.50	94.91	94.81	95.37	95.61
14	MANIPUR	65.20	55.80	48.80	40.00	42.30	22.80	59.16	39.81	30.59	19.04	37.29	23.90
15	MEGHALAYA	44.60	44.20	18.50	23.80	22.40	35.10	44.08	44.72	17.64	20.97	24.13	39.26
16	MIZORAM	65.10	46.10	36.30	40.70	23.20	37.20	77.36	75.73	60.05	62.26	46.94	52.06
17	NAGALAND	43.90	31.90	25.30	19.40	33.60	23.90	52.28	46.80	29.96	26.93	35.40	29.64
18	ORISSA	79.20	74.60	59.80	82.10	69.80	81.50	95.00	96.00	93.00	94.00	79.11	86.99
19	PUNJAB	99.80	99.10	99.80	98.20	99.50	99.00	99.76	98.61	99.61	95.95	99.54	98.47
20	RAJASTHAN	95.60	76.60	97.60	89.50	97.50	94.13	91.45	77.59	73.48	77.71	97.02	89.28
21	SIKKIM	50.90	33.10	51.80	56.40	44.30	39.10	53.61	53.61	42.67	41.27	43.04	42.36
22	TAMIL NADU	100.00	100.00	100.00	100.00	98.50	96.10	100.00	100.00	100.00	100.00	99.63	97.91
23	TRIPURA	60.00	81.00	61.30	57.10	62.30	71.00	26.47	39.35	29.69	34.07	43.26	47.94
24	UTTAR PRADESH	97.80	93.80	94.10	94.10	94.90	94.00	97.02	97.92	92.64	89.71	94.50	95.57
25	WEST BENGAL	53.60	48.90	55.00	56.50	64.60	67.50	55.00	55.00	59.00	59.00	72.99	72.78
26	A & N ISLANDS	96.10	88.40	93.60	94.30	96.50	93.00	97.67	94.02	97.72	96.85	97.96	98.28
27	CHANDIGARH	0.00	0.00	100.00	100.00	100.00	100.00	100.00	100.00	100.00	100.00	100.00	100.00
28	DADRA & NAGAR HAVELI	91.50	100.00	94.70	95.40	94.80	88.90	90.00	98.00	94.08	93.09	94.95	100.00
29	DAMAN & DIU	100.00	100.00	99.40	96.80	96.90	97.20	99.96	99.48	99.18	97.62	98.88	98.30
30	DELHI	0.00	0.00	0.00	0.00	0.00	0.00	90.76	85.21	95.68	98.90	95.78	94.73
31	LAKSHADWEEP	86.90	76.30	86.40	77.80	90.40	98.10	99.37	100.00	100.00	100.00	97.95	100.00
32	PONDICHERY	100.00	100.00	100.00	100.00	100.00	100.00	99.45	85.75	99.15	94.24	99.18	96.54
	INDIA	85.03	86.73	87.36	89.34	88.51	90.88	86.50	86.60	88.40	90.80	88.00	90.70

CHAPTER - VII

PLAN STATISTICS ON EDUCATION

TABLE NOs 7.1 TO 7.4

TABLE NO. 7.1

PLAN OUTLAY AND EXPENDITURE ON EDUCATION DURING VARIOUS PLANS

PLAN/YEAR	SECTOR	OUTLAY FOR EDUCATION (Rs. in Crores)	Percentage of outlay for Edn. to total plan	Expenditure on Education (Rs. in Crores)	Percentage of Expd. on Edu- cation to Total Plan
1	2	3	4	5	6
FIRST PLAN 1951-56	CENTRE	44	4.9	32	6.4
	STATE	126	8.7	131	8.3
	TOTAL	170	7.2	153	7.9
SECOND PLAN 1956-61	CENTRE	95	2.7	70	2.7
	STATE	212	9.2	203	9.5
	TOTAL	307	5.8	273	5.8
THIRD PLAN 1961-66	CENTRE	148	4.1	152	3.6
	STATE	412	10.6	437	10.0
	TOTAL	560	7.5	589	6.9
FOURTH PLAN 1969-74	CENTRE	271	3.1	197	2.4
	STATE	551	7.8	550	7.4
	TOTAL	822	5.2	747	9.9
FIFTH PLAN 1974-79	CENTRE	405	2.1	308	NA
	STATE	880	4.5	835	NA
	TOTAL	1285	3.3	1143	NA
SIXTH PLAN 1980-85	CENTRE	735	1.6	622	NA
	STATE	1789	3.6	1997	NA
	TOTAL	2524	2.6	2619	NA
SEVENTH PLAN 1985-90	CENTRE	2389	2.5	3037	2.9
	STATE	3994	4.7	4596	6.6
	TOTAL	6383	3.6	7633	4.3

NA Not available

TABLE - 7.2

PROGRESS OF EXPENDITURE ON EDUCATION DURING EIGHTH FIVE YEAR PLAN 1992 - 97
(Rs. in crores)

SECTOR	Seventh	Eighth	1991-92		1992-93		1993-94		1994-95	
	Five Year Plan 1985-90 Expdt.	Five Year Plan 1992-97 Out-lay	Budgeted Estimates	Actual	Budgeted Estimates	Actual	Budgeted Estimates	Actual	Budgeted Estimates	Actual Estimates
1	2	3	4	5	6	7	8	9	10	11
ELEMENTARY EDUCATION	724 (24)	2880 (39)	279 (27)	283 (30)	284 (30)	307 (32)	442 (34)	387 (31)	523 (34)	650 (35)
ADULT EDUCATION	309 (10)	1400 (19)	120 (12)	100 (10)	120 (13)	98 (10)	178 (14)	166 (13)	214 (14)	217 (11)
SECONDARY EDUCATION	558 (18)	1519 (20)	218 (21)	176 (18)	205 (22)	222 (23)	306 (23)	303 (25)	335 (22)	368 (20)
UNIVERSITY HIGHER EDU	631 (21)	702 (9)	152 (15)	161 (17)	150 (15)	152 (16)	161 (12)	158 (13)	220 (14)	315 (17)
OTHER EDUCA PROGRAMME	199 (7)	118 (2)	78 (8)	75 (8)	19 (2)	19 (2)	27 (2)	24 (2)	26 (1)	32 (2)
TOTAL GENER EDUCATION	2422 (80)	6619 (89)	847 (82)	795 (83)	782 (82)	798 (83)	1111 (85)	1038 (84)	1318 (85)	1576 (85)
TECHNICAL EDUCATION	615 (20)	824 (11)	184 (18)	158 (17)	170 (18)	163 (17)	198 (15)	194 (16)	231 (15)	271 (15)
TOTAL EDUCATION	3037 (100)	7443 (100)	1031 (100)	953 (100)	952 (100)	961 (100)	1310 (100)	1232 (100)	1549 (100)	1847 (100)

TABLE - 7.3
EXPENDITURE ON EDUCATION OF CENTRE & STATES - SECTOR WISE
(Rs. in crores)

SECTOR	FIRST PLAN		SECOND PLAN		THIRD PLAN		FOURTH PLAN		FIFTH PLAN		SIXTH PLAN		SEVENTH PLAN		1990-91		1991 - 92	
	PLAN	NON PLAN	PLAN	NON PLAN	PLAN	NON PLAN	PLAN	NON PLAN	PLAN	NON PLAN	PLAN	NON PLAN	PLAN	NON PLAN	PLAN	NON PLAN	PLAN	NON PLAN
1	2	3	4	5	6	7	8	9	10	11	12	13	14	15	16	17	18	19
ELEMENTARY EDU	85.00	91.93	95.00	240.18	201.00	490.48	213.13	1958.29	345.41	4256.57	841.39	9895.13	2865.87	21748.96	803.90	7151.63	966.61	7717.71
SECONDARY EDU	20.00	62.02	51.00	112.16	103.00	251.21	161.10	1329.29	245.87	2891.06	534.38	7017.20	1651.90	1512.18	484.93	5046.18	533.04	5665.81
ADULT EDUCATION	a	17.88	a	41.14	a	a	12.60	67.94	24.81	41.49	153.37	39.16	609.80	121.64	217.95	55.20	179.06	49.45
UNIVERSITY & HIGHER EDU	14.00	29.90	48.00	50.99	87.00	106.54	188.32	447.25	318.77	1160.53	560.40	2892.48	1091.59	6630.83	245.01	2066.84	264.47	2179.31
TECHNICAL EDU	20.00	a	49.00	a	125.00	51.14	78.69	96.37	107.12	334.11	272.86	685.83	965.11	1514.21	265.38	487.63	286.15	523.30
OTHER EDUCATION PROGRAMME	14.00	76.27	30.00	186.59	73.00	206.52	93.67	318.95	101.48	327.28	256.31	667.01	448.86	979.46	113.55	255.46	132.63	260.04
TOTAL	153.00	278.00	273.00	631.06	589.00	1065.89	747.51	4218.09	1143.46	9011.04	2618.71	21195.81	7633.13	46157.28	2130.72	15062.94	2361.96	16395.62

a Separate figures are not available

TABLE - 7.4

PERCENTAGE EXPENDITURE ON EACH SUB SECTOR OF EDUCATION TO
TOTAL EXPENDITURE ON EDUCATION OF ALL SECTORS/UTs AND CENTRE

YEAR	ELEMENTARY EDUCATION	SECONDARY EDUCATION	ADULT EDUCATION	TECHNICAL EDUCATION	UNIV./HIGHER EDUCATION	OTHRs	TOTAL
1	2	3	4	5	6	7	8
1970-71	41.67	29.13	2.23	5.40	12.28	9.30	100.00
1971-72	41.42	29.41	2.03	5.43	12.24	9.47	100.00
1972-73	44.02	29.94	0.79	5.13	13.11	7.01	100.00
1973-74	44.35	30.68	1.07	4.66	12.85	6.39	100.00
1974-75	46.27	31.42	0.80	4.31	13.41	3.80	100.00
1975-76	46.16	31.27	0.82	4.45	13.42	3.88	100.00
1976-77	45.25	31.07	0.84	4.35	14.59	3.89	100.00
1977-78	45.29	30.80	0.39	4.27	15.38	3.87	100.00
1978-79	44.24	30.26	0.51	4.36	15.34	5.29	100.00
1979-80	43.63	31.09	1.30	4.17	15.65	4.15	100.00
1980-81	45.56	30.73	0.75	4.06	14.33	4.57	100.00
1981-82	43.82	32.33	0.79	4.03	15.25	3.74	100.00
1982-83	45.62	31.77	0.79	4.03	14.29	3.52	100.00
1983-84	45.38	31.69	0.98	3.92	14.25	3.79	100.00
1984-85	44.94	31.84	0.72	4.07	14.52	3.91	100.00
1985-86	46.24	30.76	1.17	4.63	14.04	3.15	100.00
1986-87	45.94	30.78	1.20	4.46	14.21	3.41	100.00
1987-88	46.50	30.87	1.29	5.07	13.85	2.35	100.00
1988-89	44.64	32.06	1.57	4.65	14.67	2.41	100.00
1989-90	45.79	31.38	1.42	4.32	14.69	2.40	100.00
1990-91	46.27	32.17	1.59	4.38	13.45	2.15	100.00
1991-92	46.30	33.05	1.22	4.32	13.03	2.09	100.00
1992-93	46.32	32.50	1.15	4.37	12.92	2.75	100.00
1993-94	46.17	31.44	1.36	4.47	12.19	4.36	100.00

CHAPTER - VIII

SCHOOL BUILDINGS & PLAY GROUNDS

TABLE NOs 8.1 TO 8.4

TABLE - 8.1

Schools having scope for additional construction - All India-1986

Type of School	Management	Land available as well as construction on upper storey possible	Only land available	Only construction on upper storey possible	Neither land available nor construction on upper storey possible	Total
1	2	3	4	5	6	7
PRIMARY	Government	18381	132662	6644	26716	184403
	Local Body	24854	163258	13581	22251	223944
	Private Aided	2192	6676	2162	2411	13441
	Private Unaided	1286	3866	1289	1413	7854
	TOTAL	46713	306462	23676	52791	429642
MIDDLE	Government	5636	37721	2816	5246	51419
	Local Body	5271	25090	3102	2734	36197
	Private Aided	1695	10343	1477	1662	15177
	Private Unaided	1755	3387	1150	1080	7372
	TOTAL	14357	76541	8545	10722	110165
SECONDARY	Government	2944	10972	1471	1111	16498
	Local Body	893	2095	494	294	3776
	Private Aided	2962	8656	1925	1417	14960
	Private Unaided	444	2405	281	513	3643
	TOTAL	7243	24128	4171	3335	38877
HR. SECONDARY	Government	1025	3090	489	274	4878
	Local Body	46	125	36	13	220
	Private Aided	1658	2208	958	363	5187
	Private Unaided	102	191	68	107	468
	TOTAL	2831	5614	1551	757	10753
TOTAL		142288	825490	75886	135210	1178874

Source : Fifth All India Educational Survey, NCERT, Table-91.

TABLE NO.- 8.2

Distribution of Schools according to Type of Accomodation All India - 1986

TYPE OF SCHOOL	RURAL/URBAN	PUCKA BUILD-ING	PARTLY PUCKA BUILDING	KACHHA BUILDING	THATCH-ED HUTS	TENTS	OPEN SPACE	TOTAL
1	2	3	4	5	6	7	8	9
PRIMARY	RURAL	259282	77288	70351	28299	2509	38094	475823
	URBAN	38201	8778	3264	924	63	1677	52907
	TOTAL	297483	86066	73615	29223	2572	39771	528730
MIDDLE	RURAL	75072	22224	10459	2301	258	2773	113087
	URBAN	21347	3337	851	159	57	178	25929
	TOTAL	96419	25561	11310	2460	315	2951	139016
SECONDARY	RURAL	26724	7636	3425	578	79	150	38862
	URBAN	11629	1634	357	42	20	16	13698
	TOTAL	38353	9470	3852	620	99	166	52560
HIGHER SECONDARY	RURAL	6119	870	70	58	5	14	7136
	URBAN	7705	567	21	11	16	9	8329
	TOTAL	13824	1437	91	69	21	23	15465

Source : Fifth All India Educational Survey, NCERT - 1986

TABLE NO. - 8.3(a)

ADDITIONAL CLASSROOMS REQUIRED IN PRIMARY SCHOOLS IN RURAL AND URBAN AREAS
ALL INDIA - 1986

AREA	ADDITIONAL CLASSROOM REQUIRED						TOTAL
	ONE	TWO	THREE	FOUR	FIVE	MORE THAN FIVE	
1	2	3	4	5	6	7	8
RURAL	101631 (25.83)	112704 (28.64)	87582 (22.26)	51488 (13.08)	31816 (8.08)	8315 (2.11)	393536 (100.00)
URBAN	8496 (23.53)	9602 (26.59)	7352 (20.36)	5174 (14.33)	3172 (8.79)	2310 (6.40)	36106 (100.00)
TOTAL	110127 (25.63)	122306 (28.47)	94934 (22.10)	56662 (13.19)	34988 (8.14)	10625 (2.47)	429642 (100.00)

Note: Figures within Parentheses indicates percentages.

Sources Fifth All India Educational Survey 1986 NCERT(Statement 10.9)

TABLE NO. - 8.3(b)

ADDITIONAL CLASSROOMS REQUIRED IN MIDDLE/SECONDARY/HIGH SECONDARY
SCHOOLS IN RURAL AND URBAN AREAS ALL INDIA - 1986

ADDITIONAL CLASSROOM REQUIRED					
AREA	1 - 2	3 - 4	5 - 7	MORE THAN 7	TOTAL
1	2	3	4	5	6
(a) Middle Schools					
RURAL	39863 (42.71)	33838 (36.26)	16554 (17.74)	3018 (3.29)	93323 (100.00)
URBAN	6812 (40.45)	5271 (31.30)	3174 (18.14)	1585 (9.41)	16842 (100.00)
TOTAL	46675 (42.37)	39109 (35.50)	19728 (17.91)	4653 (4.22)	110165 (100.00)
(b) Secondary schools					
RURAL	15634 (51.47)	11740 (36.65)	2266 (7.46)	736 (2.42)	30376 (100.00)
URBAN	3968 (46.68)	3252 (38.25)	800 (9.41)	481 (5.66)	8501 (100.00)
TOTAL	196042 (50.42)	14992 (38.56)	3066 (7.89)	1217 (3.13)	38877 (100.00)
(c) Higher Secondary Schools					
RURAL	2048 (37.39)	2381 (43.46)	753 (13.75)	296 (5.40)	5478 (100.00)
URBAN	1986 (37.65)	2062 (39.09)	792 (15.01)	435 (8.25)	5275 (100.00)
TOTAL	4034 (37.51)	4443 (41.32)	1545 (14.39)	731 (6.80)	10753 (100.00)

Note: Figures within Parentheses indicates parentages.

Sources Fifth All India Educational Survey 1986 NCERT(Statement 10.10,10.11,10.12)

Table - 8.4

Number of Schools with Playground Facilities 1986

Sno.	State/Union Territories	Primary Schools			Middle Schools			Secondary Schools			Higher Secondary Schools		
		Total	With Play Xage Ground	%age	Total	With Play Xage Ground	%age	Total	With Play Xage Ground	%age	Total	With Play Xage Ground	%age
1	2	3	4	5	6	7	8	9	10	11	12	13	14
1	ANDHRA PRADESH	44346	24357	54.9	5647	4002	70.9	5034	4288	85.2	560	457	81.6
2	ARUNACHAL PRADESH	952	755	79.3	182	156	85.7	50	45	90.0	31	30	96.8
3	ASSAM	25873	6409	24.8	4991	3548	71.1	2230	2230	100.0	365	365	100.0
4	BIHAR	51377	15168	29.5	12211	6630	54.3	3626	3243	89.4	253	232	91.7
5	GOA	993	594	59.8	123	88	71.5	297	263	88.6	23	20	87.0
6	GUJARAT	12709	9313	73.3	16192	12987	80.2	3302	3204	97.0	1242	1207	97.2
7	HARYANA	4849	4032	83.2	1161	1021	87.9	1899	1752	92.3	180	175	97.2
8	HIMACHAL PRADESH	6904	4430	64.2	1020	779	76.4	801	683	85.3	119	114	95.8
9	JAMMU & KASHMIR	7466	3334	44.7	2196	1429	65.1	846	656	77.5	180	161	89.4
10	KARNATAKA	23023	11712	50.9	14969	10561	70.6	3572	2919	81.7	929	857	92.2
11	KERALA	6096	3266	53.6	3547	2345	66.1	2363	1878	79.5	84	69	82.1
12	MADHYA PRADESH	64089	36101	56.3	12692	9268	73.0	1605	1299	80.9	1811	1542	85.1
13	MAHARASHTRA	38094	27268	71.6	16919	13238	78.2	7187	5931	82.5	1382	1196	86.5
14	MANIPUR	2757	1602	58.1	436	347	79.6	363	324	89.3	10	10	100.0
15	MEGHALAYA	3692	2187	59.2	665	506	76.1	288	251	87.2	2	2	100.0
16	MIZORAM	1005	881	87.7	463	394	85.1	160	134	83.8	0	0	****,*
17	NAGALAND	1131	747	66.0	291	203	69.8	95	68	71.6	0	0	****,*
18	ORISSA	34178	10359	30.3	8271	5125	62.0	3955	3402	86.0	15	14	93.3
19	PUNJAB	12838	8788	68.5	1445	1226	84.8	2247	2055	91.5	283	257	90.8
20	RAJASTHAN	28103	18563	66.1	8334	6404	76.8	2203	1963	89.1	938	893	95.2
21	SIKKIM	468	196	41.9	121	82	67.8	55	50	90.9	13	13	100.0
22	TAMIL NADU	29268	25336	86.6	5666	5192	91.6	2688	2394	89.1	1679	1454	86.6
23	TRIPURA	1927	1463	75.9	419	356	85.0	280	252	90.0	100	98	98.0
24	UTTAR PRADESH	75564	55013	72.8	17325	14207	82.0	2485	2238	90.1	3373	3132	92.9
25	WEST BENGAL	48456	34246	70.7	3127	2596	83.0	4483	3292	73.4	1162	927	79.8
26	A & N ISLANDS	177	77	43.5	40	24	60.0	23	18	78.3	27	18	66.7
27	CHANDIGARH	44	33	75.0	31	29	93.5	71	69	97.2	12	12	100.0
28	DADRA & NAGAR HAVELI	124	68	54.8	36	24	66.7	4	4	100.0	3	3	100.0
29	DAMAN & DIU	32	15	46.9	16	12	75.0	15	14	93.3	2	2	100.0
30	DELHI	1838	1466	79.8	366	262	71.6	259	236	91.1	663	597	90.0
31	LAKSHADWEEP	18	4	22.2	4	1	25.0	9	9	100.0	2	2	100.0
32	PONDICHERRY	339	209	61.7	100	64	64.0	65	45	69.2	22	22	100.0
33	INDIA	528730	307982	58.2	139006	103106	74.2	52560	45209	86.0	15465	13881	89.8

CHAPTER - IX

EXAMINATION RESULTS

TABLE NOs 9.1 TO 9.30

TABLE 9.1
MATRICULATION/SCHOOL LEAVING CERTIFICATE etc. - 1987-88

S.no.	State/UTs	Number Appeared			Number Passed			Pass Percentage		
		Boys	Girls	Total	Boys	Girls	Total	Boys	Girls	Total
1	2	3	4	5	6	7	8	9	10	11
1	ANDHRA PRADESH	638571	233604	872175	178541	80149	258690	27.96	34.31	29.66
2	ARUNACHAL PRADESH	2492	966	3458	1084	341	1425	43.50	35.30	41.21
3	ASSAM	135501	93090	228591	40781	16387	57168	30.10	17.60	25.01
4	BIHAR	445358	111339	556697	232765	58191	290956	52.26	52.26	52.26
5	GOA	9506	7065	16571	5186	4045	9231	54.56	57.25	55.71
6	GUJARAT	248729	131831	380560	136764	82262	219026	54.99	62.40	57.55
7	HARYANA	82043	32555	114598	31678	14369	46047	38.61	44.14	40.18
8	HIMACHAL PRADESH	42550	22306	64856	17408	8779	26187	40.91	39.36	40.38
9	JAMMU & KASHMIR	79947	28452	108399	17907	6850	24757	22.40	24.08	22.84
10	KARNATAKA	307920	144304	452224	127074	87001	214075	41.27	60.29	47.34
11	KERALA	261386	244954	506340	113875	113516	227391	43.57	46.34	44.91
12	MADHYA PRADESH	288347	76048	364395	143051	43927	187048	49.61	57.84	51.35
13	MAHARASHTRA	589124	260217	849341	250858	128656	379514	42.58	49.44	44.68
14	MANIPUR	15110	11851	26961	5527	3435	8962	36.58	28.98	33.24
15	MEGHALAYA	7054	5325	12379	2379	1617	3996	33.73	30.37	32.28
16	MIZORAM	3466	2962	6428	1469	1085	2554	42.38	36.53	39.73
17	NAGALAND	4956	2633	7589	894	584	1478	18.04	22.18	19.48
18	ORISSA	86425	40098	126523	41489	17011	58500	48.01	42.42	46.24
19	PUNJAB	134751	67016	201767	123203	59388	182591	91.43	88.62	90.50
20	RAJASTHAN	257015	59870	316885	96639	25157	121796	37.60	42.02	38.44
21	SIKKIM	961	509	1470	297	136	433	30.91	26.72	29.46
22	TAMIL NADU	234729	146665	381394	111797	85730	197527	47.63	58.45	51.79
23	TRIPURA	13834	8958	22792	4549	2585	7134	32.88	28.86	31.30
24	UTTAR PRADESH	1170998	267593	1438591	681716	188780	670496	41.14	70.55	46.61
25	WEST BENGAL	228575	202698	431273	99806	88508	188314	52.17	44.37	49.45
26	A & N ISLANDS	1562	1039	2601	795	516	1311	50.90	49.66	50.40
27	CHANDIGARH	1516	1625	3141	1120	1219	2339	73.88	75.02	74.47
28	DADRA & NAGAR HAVELI	343	223	566	160	95	256	46.65	43.05	45.23
29	DAMAN & DIU	838	362	1200	332	163	495	39.62	45.03	41.25
30	DELHI	115998	77567	193565	82664	50223	142892	71.26	77.65	73.82
31	LAKSHADWEEP	260	185	445	175	93	268	67.31	50.27	60.22
32	PONDICHERY	3971	2492	6463	2576	1565	4141	64.87	62.80	64.07
INDIA		5413836	2286402	7702738	2354569	1132429	3536998	43.49	51.72	45.92

* Related to the year 1986-87

TABLE 9.2
HIGHER SECONDARY (New Pattern 10+2)
Old Patterns & Intermediate/Pre-degree/Pre-University
Year 1987-88

S.no.	State/UTs	Number Appeared			Number Passed			Pass Percentage		
		Boys	Girls	Total	Boys	Girls	Total	Boys	Girls	Total
1	2	3	4	5	6	7	8	9	10	11
1	ANDHRA PRADESH	858	358	1216	702	291	993	81.82	81.28	81.66
2	ARUNACHAL PRADESH	1024	286	1310	728	181	909	71.09	63.29	69.39
3	ASSAM	64749	33276	98025	23775	10484	34259	36.72	31.51	34.95
4	BIHAR	55287	39144	94431	39885	29638	69523	72.14	75.72	73.62
5	GOA	4207	3599	7806	2170	2076	4246	51.58	57.68	54.39
6	GUJARAT	101171	53400	154571	52255	36313	88568	51.65	68.00	57.30
7	HARYANA	41869	17653	59522	19667	11126	30793	46.97	63.03	51.73
8	HIMACHAL PRADESH	8741	2966	11707	2709	2508	5217	30.99	84.56	44.56
9	JAMMU & KASHMIR	22889	10522	33411	9631	3798	13429	42.08	36.10	40.19
10	KARNATAKA	149336	57149	206485	39413	23821	63234	26.39	41.68	30.62
11	KERALA	1480	1506	2986	825	1110	1935	55.74	73.71	64.80
12	MADHYA PRADESH	45669	17611	63280	39581	16372	55953	86.67	92.96	88.42
13	MAHARASHTRA	183888	85121	269009	89311	56000	145311	48.57	65.79	54.02
14	MANIPUR	168	97	265	33	29	62	19.64	29.90	23.40
15	MEGHALAYA	0	0	0	0	0	0	***. **	***. **	***. **
16	MIZORAM	0	0	0	0	0	0	***. **	***. **	***. **
17	NAGALAND	0	0	0	0	0	0	0.00	***. **	***. **
18	ORISSA	85453	30228	115681	24890	10935	35825	29.13	36.18	30.97
19	PUNJAB	68162	23669	91831	26681	9519	36200	39.14	40.22	39.42
20	RAJASTHAN	138610	34344	172954	73697	22287	95984	53.17	64.89	55.50
21	SIKKIM	284	122	406	176	73	249	61.97	59.84	61.33
22	TAMIL NADU	105136	64489	167625	78275	52070	130345	75.89	80.74	77.76
23	TRIPURA	5940	3533	9473	1979	1322	3301	33.32	37.42	34.85
24	UTTAR PRADESH	0	0	0	0	0	0	***. **	***. **	***. **
25	WEST BENGAL	173726	85567	259293	82849	40806	123655	47.69	47.69	47.69
26	A & N ISLANDS	825	579	1404	650	496	1146	78.79	85.66	81.62
27	CHANDIGARH	143	367	510	103	323	426	72.03	88.01	83.53
28	DADRA & NAGAR HAVELI	143	65	208	63	39	102	44.06	60.00	49.04
29	DAMAN & DIU	313	98	411	155	71	226	49.52	72.45	54.99
30	DELHI	60394	43913	104307	47561	39014	86575	78.75	88.84	83.00
31	LAKSHADWEEP	0	0	0	0	0	0	***. **	***. **	***. **
32	PONDICHERY	1328	1056	2384	1020	722	1742	76.81	68.37	73.07
	INDIA	1319793	610718	1930511	658784	371424	1030208	49.91	60.81	53.36

Relates to the year 1986-87

TABLE 9.3
POST MATRIC DIPLOMA/CERTIFICATE (Not leading to degree) Non-Affiliated
Commerce/Business Management
Year 1987-88

S.No.	State/UTs	Number Appeared			Number Passed			Pass Percentage		
		Boys	Girls	Total	Boys	Girls	Total	Boys	Girls	To
1	2	3	4	5	6	7	8	9	10	
1	ANDHRA PRADESH	0	0	0	0	0	0	***. **	***. **	***
2	ARUNACHAL PRADESH	0	0	0	0	0	0	***. **	***. **	***
3	ASSAM	104	37	141	69	19	88	66.35	51.35	62
4	BIHAR	0	0	0	0	0	0	***. **	***. **	***
5	GOA	33	84	117	26	52	78	78.79	61.90	66
6	GUJARAT	0	0	0	0	0	0	***. **	***. **	***
7	HARYANA	56	144	200	29	53	82	51.79	36.81	41
8	HIMACHAL PRADESH	276	186	462	200	140	340	72.46	75.27	73
9	JAMMU & KASHMIR	0	0	0	0	0	0	***. **	***. **	***
10	KARNATAKA	0	0	0	0	0	0	***. **	***. **	***
11	KERALA	30041	33041	63082	14060	16464	30524	46.80	49.83	48
12	MADHYA PRADESH	0	0	0	0	0	0	***. **	***. **	***
13	MAHARASHTRA @	0	170337	170337	0	97299	97299	***. **	57.12	51
14	MANIPUR	31	16	47	24	7	31	77.42	43.75	65
15	MEGHALAYA	0	0	0	0	0	0	***. **	***. **	***
16	MIZORAM	2	2	4	0	0	0	0.00	0.00	0
17	NAGALAND	0	0	0	0	0	0	***. **	***. **	***
18	ORISSA	0	0	0	0	0	0	***. **	***. **	***
19	PUNJAB	1015	673	1688	572	324	896	56.47	48.14	53
20	RAJASTHAN	98	4	102	63	4	67	64.29	100.00	65
21	SIKKIM	0	0	0	0	0	0	***. **	***. **	***
22	TAMIL NADU	309	62	371	305	60	365	98.71	96.77	98
23	TRIPURA	13	4	17	5	3	8	38.46	75.00	47
24	UTTAR PRADESH	0	0	0	0	0	0	***. **	***. **	***
25	WEST BENGAL	0	0	0	0	0	0	***. **	***. **	***
26	A & N ISLANDS	0	0	0	0	0	0	***. **	***. **	***
27	CHANDIGARH	0	0	0	0	0	0	***. **	***. **	***
28	DADRA & NAGAR HAVELI	0	0	0	0	0	0	***. **	***. **	***
29	DAMAN & DIU	0	0	0	0	0	0	***. **	***. **	***
30	DELHI	363	154	517	190	115	305	52.34	74.68	58
31	LAKSHADWEEP	0	0	0	0	0	0	***. **	***. **	***
32	PONDICHERY	16	13	29	2	3	5	12.50	23.08	17
	INDIA	32355	204757	237112	14545	114543	130088	48.05	55.94	54

@ Relates to the year 1986-87

TABLE 9.4
POST MATRIC DIPLOMA/CERTIFICATE (Not leading to degree) Non-Affiliated
Engineering/Technology/Architecture
Year: 1987-88

S.no.	State/UTs	Number Appeared			Number Passed			Pass Percentage		
		Boys	Girls	Total	Boys	Girls	Total	Boys	Girls	Total
1	2	3	4	5	6	7	8	9	10	11
1	ANDHRA PRADESH	32601	3157	35758	17377	1755	19132	53.30	55.59	53.50
2	ARUNACHAL PRADESH	0	0	0	0	0	0	0.0	0.0	0.0
3	ASSAM	1817	154	1971	1450	111	1561	79.80	72.08	79.20
4	BIHAR	0	0	0	0	0	0	0.0	0.0	0.0
5	GOA	1003	63	1066	669	35	704	66.70	55.56	66.04
6	GUJARAT	0	0	0	0	0	0	0.0	0.0	0.0
7	HARYANA	13088	4511	17599	8383	3381	11764	64.05	74.95	66.84
8	HIMACHAL PRADESH	385	86	471	371	60	431	96.36	69.77	91.51
9	JAMMU & KASHMIR	2072	847	2919	1006	557	1563	48.55	65.76	53.55
10	KARNATAKA	0	0	0	0	0	0	0.0	0.0	0.0
11	KERALA	3208	1147	4355	2231	611	2842	69.54	53.27	65.26
12	MADHYA PRADESH	11176	546	11722	5569	248	5817	49.83	45.42	49.62
13	MAHARASHTRA	40	78	118	26	58	84	65.00	74.36	71.19
14	MANIPUR	59	15	74	44	13	57	74.58	86.67	77.03
15	MEGHALAYA	84	2	86	46	2	48	54.76	100.00	55.81
16	MIZORAM	61	4	65	59	3	62	96.72	75.00	95.38
17	NAGALAND	185	73	258	107	45	152	57.84	61.64	58.91
18	ORISSA	5098	262	5360	4532	236	4768	88.90	90.08	88.96
19	PUNJAB	5051	207	5258	3480	133	3613	68.90	64.25	68.71
20	RAJASTHAN	959	78	1037	597	56	653	62.25	71.79	62.97
21	SIKKIM	0	0	0	0	0	0	0.0	0.0	0.0
22	TAMIL NADU	16081	2175	18256	7713	1441	9154	47.96	66.25	50.14
23	TRIPURA	81	0	81	81	0	81	100.00	0.0	100.00
24	UTTAR PRADESH	0	0	0	0	0	0	0.0	0.0	0.0
25	WEST BENGAL	0	0	0	0	0	0	0.0	0.0	0.0
26	A & N ISLANDS	6	8	14	5	5	10	83.33	62.50	71.43
27	CHANDIGARH	0	0	0	0	0	0	0.0	0.0	0.0
28	DADRA & NAGAR HAVELI	0	0	0	0	0	0	0.0	0.0	0.0
29	DAMAN & DIU	0	0	0	0	0	0	0.0	0.0	0.0
30	DELHI	5410	1630	7040	4845	1453	6298	89.56	89.14	89.46
31	LAKSHADWEEP	0	0	0	0	0	0	0.0	0.0	0.0
32	PONDICHERY	116	39	155	56	15	71	48.28	38.46	45.81
INDIA		98581	15082	113663	58647	10218	68865	59.49	67.75	60.59

a Relates to the year 1986-87

TABLE 9.5
POST MATRIC DIPLOMA/CERTIFICATE(Not leading to degree) Non-Affiliated
Medicine/Nursing/Dentistry
Year : 1987 - 88

S.no.	State/UTs	Number Appeared			Number Passed			Pass Percentage		
		Boys	Girls	Total	Boys	Girls	Total	Boys	Girls	Total
1	2	3	4	5	6	7	8	9	10	11
1	ANDHRA PRADESH	0	0	0	0	0	0	***.***	***.***	***.***
2	ARUNACHAL PRADESH	0	0	0	0	0	0	***.***	***.***	***.***
3	ASSAM	0	0	0	0	0	0	***.***	***.***	***.***
4	BIHAR	0	0	0	0	0	0	***.***	***.***	***.***
5	GOA	48	68	116	26	47	73	54.17	69.12	62.93
6	GUJARAT	41	668	709	27	499	526	65.85	74.70	74.19
7	HARYANA	0	0	0	0	0	0	***.***	***.***	***.***
8	HIMACHAL PRADESH	0	0	0	0	0	0	***.***	***.***	***.***
9	JAMMU & KASHMIR	0	0	0	0	0	0	***.***	***.***	***.***
10	KARNATAKA	0	0	0	0	0	0	***.***	***.***	***.***
11	KERALA	426	1660	2086	148	1444	1592	34.74	86.99	76.32
12	MADHYA PRADESH	171	25	196	80	10	90	46.78	40.00	45.92
13	MAHARASHTRA	97	64	161	39	38	77	40.21	59.38	47.83
14	MANIPUR	0	84	84	0	57	57	***.***	67.86	67.86
15	MEGHALAYA	0	0	0	0	0	0	***.***	***.***	***.***
16	MIZORAM	25	17	42	25	17	42	100.00	100.00	100.00
17	NAGALAND	0	0	0	0	0	0	***.***	***.***	***.***
18	ORISSA	0	0	0	0	0	0	***.***	***.***	***.***
19	PUNJAB	1	901	902	1	659	660	100.00	73.14	73.17
20	RAJASTHAN	538	2944	3482	398	2323	2721	73.98	78.91	78.14
21	SIKKIM	0	0	0	0	0	0	***.***	***.***	***.***
22	TAMIL NADU	0	0	0	0	0	0	***.***	***.***	***.***
23	TRIPURA	28	191	219	20	160	180	71.43	83.77	82.19
24	UTTAR PRADESH	0	0	0	0	0	0	***.***	***.***	***.***
25	WEST BENGAL	0	0	0	0	0	0	***.***	***.***	***.***
26	A & N ISLANDS	0	0	0	0	0	0	***.***	***.***	***.***
27	CHANDIGARH	29	7	36	26	7	33	89.66	100.00	91.67
28	DADRA & NAGAR HAVELI	0	0	0	0	0	0	***.***	***.***	***.***
29	DAMAN & DIU	0	0	0	0	0	0	***.***	***.***	***.***
30	DELHI	50	254	304	44	197	241	88.00	77.56	79.28
31	LAKSHADWEEP	0	0	0	0	0	0	***.***	***.***	***.***
32	PONDICHEERY	0	0	0	0	0	0	***.***	***.***	***.***
	INDIA	1454	6883	8337	834	5458	6292	57.36	79.30	75.47

@ Relates to the year 1986-87

TABLE 9.6
POST MATRIC DIPLOMA/CERTIFICATE(Not leading to degree) Non-Affiliated
Others(including Education, Music & Fine Arts & Oriental Studies etc.)
Year : 1987 - 88

S.no.	State/UTs	Number Appeared			Number Passed			Pass Percentage		
		Boys	Girls	Total	Boys	Girls	Total	Boys	Girls	Total
1	2	3	4	5	6	7	8	9	10	11
1	ANDHRA PRADESH	3459	2142	5601	2127	1444	3571	61.49	67.41	63.76
2	ARUNACHAL PRADESH	0	0	0	0	0	0	***. **	***. **	***. **
3	ASSAM	82	0	82	0	0	0	0.00	***. **	0.00
4	BIHAR	18	2	20	16	2	18	88.89	100.00	90.00
5	GOA	76	248	324	67	215	282	88.16	86.69	87.04
6	GUJARAT	62	76	138	62	0	62	100.00	0.00	44.93
7	HARYANA	647	299	946	504	89	593	77.90	29.77	62.68
8	HIMACHAL PRADESH	938	785	1723	566	635	1201	60.34	80.89	69.70
9	JAMMU & KASHMIR	320	123	443	266	73	339	83.12	59.35	76.52
10	KARNATAKA	11519	7264	18783	5912	3000	8912	51.32	41.30	47.45
11	KERALA	2737	2966	5703	2206	2426	4632	80.60	81.79	81.22
12	MADHYA PRADESH	0	0	0	0	0	0	0	0	0
13	MAHARASHTRA @	11	19367	19378	9	11409	11418	81.82	58.91	58.92
14	MANIPUR	49	43	92	35	43	78	71.43	100.00	84.78
15	MEGHALAYA	235	209	444	168	130	298	71.49	62.20	66.37
16	MIZORAM	242	66	308	167	44	211	69.01	66.67	68.51
17	NAGALAND	29	15	44	21	13	34	72.41	86.67	77.27
18	ORISSA	5332	2180	7512	5266	2166	7432	98.76	99.36	98.94
19	PUNJAB	321	1525	1846	307	1244	1551	95.64	81.57	84.02
20	RAJASTHAN	7247	1262	8509	4824	1039	5863	66.57	82.33	68.90
21	SIKKIM	0	0	0	0	0	0	***. **	***. **	***. **
22	TAMIL NADU	6598	3730	10328	6156	3512	9668	93.30	94.16	93.61
23	TRIPURA	328	196	524	214	134	348	65.24	68.37	66.41
24	UTTAR PRADESH	11	157	168	10	129	139	90.91	82.17	82.74
25	WEST BENGAL	0	0	0	0	0	0	***. **	***. **	***. **
26	A & N ISLANDS	28	30	58	28	30	58	100.00	100.00	100.00
27	CHANDIGARH	708	865	1573	352	452	804	49.72	52.25	51.11
28	DADRA & NAGAR HAVELI	0	0	0	0	0	0	***. **	***. **	***. **
29	DAMAN & DIU	0	0	0	0	0	0	***. **	***. **	***. **
30	DELHI	438	982	1420	394	958	1352	89.95	97.56	95.21
31	LAKSHADWEEP	0	0	0	0	0	0	***. **	***. **	***. **
32	PONDICHEERY	0	0	0	0	0	0	***. **	***. **	***. **
INDIA		41435	44532	85967	29677	29187	58864	71.62	65.54	68.47

@ Relates to the year 1986-87

TABLE 9.7
SCHOOL EXAMINATION (MATRICULATION/SCHOOL LEAVING CERTIFICATE etc.
Year : 1988 - 89

S.no.	State/UTs	Number Appeared			Number Passed			Pass Percentage		
		Boys	Girls	Total	Boys	Girls	Total	Boys	Girls	Total
1	2	3	4	5	6	7	8	9	10	11
1	ANDHRA PRADESH	681588	247447	929035	185916	84170	270086	27.28	34.02	29.07
2	ARUNACHAL PRADESH *	2669	1028	3697	926	356	1282	34.69	34.63	34.68
3	ASSAM	139412	100899	240311	49894	21832	71726	35.79	21.64	29.85
4	BIHAR	549946	62293	612239	278913	32101	311014	50.72	51.53	50.80
5	GOA	12316	9619	21935	5945	4608	10553	48.27	47.91	48.11
6	GUJARAT	253818	142774	396592	134962	82202	217164	53.17	57.57	54.77
7	HARYANA	140084	53792	193876	65871	27836	93707	47.02	51.75	48.33
8	HIMACHAL PRADESH	46395	24828	71223	28283	13808	42091	60.96	55.61	59.10
9	JAMMU & KASHMIR	81757	32516	114273	24190	10701	34891	29.59	32.91	30.53
10	KARNATAKA	323318	153309	476627	141846	76568	218414	43.87	49.94	45.82
11	KERALA	253149	282522	535671	133586	131294	264880	52.77	46.47	49.45
12	MADHYA PRADESH	325732	91082	416814	133030	39733	172763	40.84	43.62	41.45
13	MAHARASHTRA	683317	309514	992831	296181	154010	450191	43.34	49.76	45.34
14	MANIPUR	17000	13656	30656	5051	3110	8161	29.71	22.77	26.62
15	MEGHALAYA *	7244	6028	13272	2510	1963	4473	34.65	32.56	33.70
16	MIZORAM *	3628	3398	7026	1484	1259	2743	40.90	37.05	39.04
17	NAGALAND	5237	3065	8302	1990	1125	3115	38.00	36.70	37.52
18	ORISSA	91086	47106	138192	44031	20518	64549	48.34	43.56	46.71
19	PUNJAB	164475	80754	245229	137151	68310	205461	83.39	84.59	83.78
20	RAJASTHAN	251846	60136	311982	96964	26483	123447	38.50	44.04	39.57
21	SIKKIM	760	382	1142	264	122	386	34.74	31.94	33.80
22	TAMIL NADU	236249	147907	384156	111774	77676	189450	47.31	52.51	49.31
23	TRIPURA *	15550	10487	26037	4320	2535	6855	27.78	24.17	26.33
24	UTTAR PRADESH	1228843	292929	1521772	474892	207203	682095	38.65	70.73	44.82
25	WEST BENGAL	202603	195629	398222	118138	104764	222902	58.31	53.55	55.97
26	A & N ISLANDS	1598	1207	2805	786	899	1685	49.19	74.48	60.07
27	CHANDIGARH	2002	2103	4105	1586	1712	3298	79.22	81.41	80.34
28	DADRA & NAGAR HAVELI	425	251	676	143	90	233	33.65	35.86	34.47
29	DAMAN & DIU	929	401	1330	540	219	759	58.13	54.61	57.07
30	DELHI ^a	135994	91209	227203	97936	70850	168786	72.01	77.68	74.29
31	LAKSHADWEEP	256	182	438	144	78	222	56.25	42.86	50.68
32	PONDICHEERY	4098	3186	7284	2697	2305	5002	65.81	72.35	68.67
INDIA		5863324	2471639	8334963	2581944	1270440	3852384	44.04	51.40	46.21

^a Relates to the year 1986-87

* Excludes supplementary & Private Candidates.

TABLE 9.8
SCHOOL EXAMINATION & HIGHER SECONDARY (New Pattern 10+2
Old Pattern, Intermediate/Pre-degree/Pre-university)
Year : 1988 - 89

S.no.	State/UTs	Number Appeared			Number Passed			Pass Percentage		
		Boys	Girls	Total	Boys	Girls	Total	Boys	Girls	Total
1	2	3	4	5	6	7	8	9	10	11
1	ANDHRA PRADESH	336153	125691	461844	64756	34696	99452	19.26	27.60	21.53
2	ARUNACHAL PRADESH	1210	389	1599	841	266	1107	69.50	68.38	69.23
3	ASSAM	69524	36212	105736	25879	12111	37990	37.22	33.44	35.93
4	BIHAR @	55287	39144	94431	39885	29638	69523	72.14	75.72	73.62
5	GOA	5296	4281	9577	2636	2151	4787	49.77	50.25	49.98
6	GUJARAT	112637	61690	174327	56328	40463	96791	50.01	65.59	55.52
7	HARYANA	61954	23334	85288	17197	10249	27446	27.76	43.92	32.18
8	HIMACHAL PRADESH	13360	5063	18423	4239	1940	6179	31.73	38.32	33.54
9	JAMMU & KASHMIR	16652	13691	30343	7773	5576	13552	46.68	40.73	44.66
10	KARNATAKA	179386	68794	248180	42783	26307	69090	23.85	38.24	27.84
11	KERALA	6230	4214	10444	2906	1946	4852	46.65	46.18	46.46
12	MADHYA PRADESH	147271	43537	190808	103090	34084	137174	70.00	78.29	71.89
13	MAHARASHTRA	294717	130291	425008	156735	88882	245617	53.18	68.22	57.79
14	MANIPUR	835	422	1257	424	235	639	50.78	55.69	50.84
15	MEGHALAYA	61	50	111	53	40	93	86.89	80.00	83.79
16	MIZORAM	72	42	114	42	17	59	58.33	40.48	51.75
17	NAGALAND	15	4	19	5	1	6	33.33	25.00	31.58
18	ORISSA	105335	53330	158665	25009	20112	45121	23.74	37.71	28.44
19	PUNJAB	77178	25454	102632	65168	18821	83989	84.44	73.94	81.84
20	RAJASTHAN	174811	45917	220728	97201	32537	129738	55.60	70.86	58.78
21	SIKKIM	275	110	385	203	85	288	73.82	77.27	74.81
22	TAMIL NADU	107010	76753	183763	75977	62168	138146	71.00	81.64	75.18
23	TRIPURA	5352	4005	9357	2947	2056	5003	55.06	51.34	53.47
24	UTTAR PRADESH	529049	155312	684361	308401	125764	434165	58.29	80.98	63.44
25	WEST BENGAL	176126	86748	262874	81616	40199	121815	46.34	46.34	46.34
26	A & N ISLANDS	694	586	1280	596	528	1124	85.88	90.10	87.81
27	CHANDIGARH	510	414	924	496	404	900	97.25	97.58	97.40
28	DADRA & NAGAR HAVELI	154	89	243	66	45	111	42.86	50.56	45.68
29	DAMAN & DIU	273	114	387	133	72	205	48.72	63.16	52.97
30	DELHI	70773	49432	120205	56576	43916	100492	79.94	88.84	83.60
31	LAKSHADWEEP	122	54	176	60	34	94	49.18	62.96	53.41
32	PONDICHEERY	1426	977	2403	1048	719	1767	73.49	73.59	73.53
	INDIA	2549748	1056144	3605812	1241069	636062	1877315	48.67	60.22	52.06

@ Relates to the year 1986-87

TABLE 9.9

POST MATRIC DIPLOMA/CERTIFICATE(Not leading to degree) Non-Affiliated
Commerce/Business Management
Year : 1988 - 89

S.no.	State/UTs	Number Appeared			Number Passed			Pass Percentage		
		Boys	Girls	Total	Boys	Girls	Total	Boys	Girls	Total
1	2	3	4	5	6	7	8	9	10	11
1	ANDHRA PRADESH	0	0	0	0	0	0	***. **	***. **	***. **
2	ARUNACHAL PRADESH	0	0	0	0	0	0	***. **	***. **	***. **
3	ASSAM	110	45	155	79	25	104	71.82	55.56	67.10
4	BIHAR @	0	0	0	0	0	0	***. **	***. **	***. **
5	GOA	33	104	137	10	32	42	30.30	30.77	30.66
6	GUJARAT	0	0	0	0	0	0	***. **	***. **	***. **
7	HARYANA	49	85	134	26	26	52	53.06	30.59	38.81
8	HIMACHAL PRADESH	247	136	383	181	103	284	73.28	75.74	74.15
9	JAMMU & KASHMIR	0	0	0	0	0	0	***. **	***. **	***. **
10	KARNATAKA	0	0	0	0	0	0	***. **	***. **	***. **
11	KERALA	65164	69380	134544	29427	30613	60040	45.16	44.12	44.62
12	MADHYA PRADESH @	0	0	0	0	0	0	***. **	***. **	***. **
13	MAHARASHTRA \$	0	170337	170337	0	97299	97299	***. **	57.12	57.12
14	MANIPUR	32	12	44	14	10	24	43.75	83.33	54.55
15	MEGHALAYA	0	0	0	0	0	0	***. **	***. **	***. **
16	MIZORAM @	0	0	0	0	0	0	***. **	***. **	***. **
17	NAGALAND	0	0	0	0	0	0	***. **	***. **	***. **
18	ORISSA	0	0	0	0	0	0	***. **	***. **	***. **
19	PUNJAB	1155	700	1855	759	367	1126	65.71	52.43	60.70
20	RAJASTHAN	108	2	110	67	2	69	62.04	100.00	62.73
21	SIKKIM	0	0	0	0	0	0	***. **	***. **	***. **
22	TAMIL NADU	291	62	353	287	58	345	98.63	93.55	97.73
23	TRIPURA	20	3	23	5	1	6	25.00	33.33	26.09
24	UTTAR PRADESH	0	0	0	0	0	0	***. **	***. **	***. **
25	WEST BENGAL @	0	0	0	0	0	0	***. **	***. **	***. **
26	A & N ISLANDS	0	0	0	0	0	0	***. **	***. **	***. **
27	CHANDIGARH	0	0	0	0	0	0	***. **	***. **	***. **
28	DADRA & NAGAR HAVELI	0	0	0	0	0	0	***. **	***. **	***. **
29	DAMAN & DIU	0	0	0	0	0	0	***. **	***. **	***. **
30	DELHI	360	151	511	290	124	414	80.56	82.12	81.02
31	LAKSHADWEEP	0	0	0	0	0	0	***. **	***. **	***. **
32	PONDICHEERY @	16	13	29	2	3	5	12.50	23.08	17.24
INDIA		67585	241030	308615	34226	130472	164698	50.64	54.13	53.37

@ Relates to the year 1986-87

\$ Relates to the year 1987-88

TABLE 9.10
POST MATRIC DIPLOMA/CERTIFICATE (Not leading to degree) Non-Affiliated
ENGG./TECH./ARCH.
Year : 1988 - 89

S.no.	State/UTs	Number Appeared			Number Passed			Pass Percentage		
		Boys	Girls	Total	Boys	Girls	Total	Boys	Girls	Total
1	2	3	4	5	6	7	8	9	10	11
1	ANDHRA PRADESH	41357	14091	55448	34340	1869	36209	83.03	13.26	65.30
2	ARUNACHAL PRADESH	0	0	0	0	0	0	*** **	*** **	*** **
3	ASSAM	2116	175	2291	1667	125	1792	78.78	71.43	78.22
4	BIHAR	0	0	0	0	0	0	*** **	*** **	*** **
5	GOA	939	49	988	635	27	662	67.63	55.10	67.00
6	GUJARAT	0	0	0	0	0	0	*** **	*** **	*** **
7	HARYANA	12153	4386	16539	9091	1585	10676	74.80	36.14	64.55
8	HIMACHAL PRADESH	542	68	610	267	55	322	49.26	80.88	52.79
9	JAMMU & KASHMIR	508	158	666	198	106	304	38.98	67.09	45.65
10	KARNATAKA	0	0	0	0	0	0	*** **	*** **	*** **
11	KERALA	3287	842	4129	2354	453	2807	71.62	53.80	67.98
12	MADHYA PRADESH @	11176	546	11722	5569	248	5817	49.83	45.42	49.62
13	MAHARASHTRA §	40	78	118	26	58	84	65.00	74.36	71.19
14	MANIPUR	68	14	82	66	14	80	97.06	100.00	97.56
15	MEGHALAYA	147	7	154	126	6	132	85.71	85.71	85.71
16	MIZORAM	55	14	69	55	14	69	100.00	100.00	100.00
17	NAGALAND	359	134	493	222	106	328	61.84	79.10	66.53
18	ORISSA	4772	268	5040	4174	218	4392	87.47	81.34	87.14
19	PUNJAB	5812	226	6038	3648	114	3762	62.77	50.44	62.31
20	RAJASTHAN	5255	444	5699	3235	336	3571	61.56	75.68	62.66
21	SIKKIM	0	0	0	0	0	0	*** **	*** **	*** **
22	TAMIL NADU	14226	1592	15818	7688	1013	8701	54.04	63.63	55.01
23	TRIPURA	68	0	68	62	0	62	91.18	*** **	91.18
24	UTTAR PRADESH	0	0	0	0	0	0	*** **	*** **	*** **
25	WEST BENGAL @	0	0	0	0	0	0	*** **	*** **	*** **
26	A & N ISLANDS	44	5	49	44	5	49	100.00	100.00	100.00
27	CHANDIGARH	0	0	0	0	0	0	*** **	*** **	*** **
28	DADRA & NAGAR HAVELI	0	0	0	0	0	0	*** **	*** **	*** **
29	DAMAN & DIU	0	0	0	0	0	0	*** **	*** **	*** **
30	DELHI	5398	1636	7034	4836	1429	6265	89.59	87.35	89.07
31	LAKSHADWEEP	0	0	0	0	0	0	*** **	*** **	*** **
32	PONDICHERY	167	72	239	69	24	93	41.32	33.33	38.91
INDIA		108489	24805	133294	78372	7805	86177	72.24	31.47	64.65

§ Relates to the year 1986-87

@ Relates to the year 1987-88

TABLE 9.11
POST MATRIC DIPLOMA/CERTIFICATE(Not leading to degree) Non-Affiliated
MEDICINE/NURSING/PHARMACY/DENTISTRY
Year : 1988 - 89

S.no.	State/UTs	Number Appeared			Number Passed			Pass Percentage		
		Boys	Girls	Total	Boys	Girls	Total	Boys	Girls	Total
1	2	3	4	5	6	7	8	9	10	11
1	ANDHRA PRADESH	0	0	0	0	0	0	***. **	***. **	***. **
2	ARUNACHAL PRADESH	0	0	0	0	0	0	***. **	***. **	***. **
3	ASSAM	0	0	0	0	0	0	***. **	***. **	***. **
4	BIHAR	0	0	0	0	0	0	***. **	***. **	***. **
5	GOA	46	36	82	22	17	39	47.83	47.22	47.56
6	GUJARAT	280	924	1204	131	577	708	46.79	62.45	58.80
7	HARYANA	248	638	886	99	526	625	39.92	82.45	70.54
8	HIMACHAL PRADESH	0	0	0	0	0	0	***. **	***. **	***. **
9	JAMMU & KASHMIR	0	0	0	0	0	0	***. **	***. **	***. **
10	KARNATAKA	0	0	0	0	0	0	***. **	***. **	***. **
11	KERALA	414	1483	1897	127	1357	1484	30.68	91.50	78.23
12	MADHYA PRADESH @	171	25	196	80	10	90	46.78	40.00	45.92
13	MAHARASHTRA \$	97	64	161	39	38	77	40.21	59.38	47.83
14	MANIPUR	0	59	59	0	56	56	***. **	94.92	94.92
15	MEGHALAYA	0	0	0	0	0	0	***. **	***. **	***. **
16	MIZORAM @	25	17	42	25	17	42	100.00	100.00	100.00
17	NAGALAND	0	0	0	0	0	0	***. **	***. **	***. **
18	ORISSA	0	0	0	0	0	0	***. **	***. **	***. **
19	PUNJAB	3	817	820	3	675	678	100.00	82.62	82.68
20	RAJASTHAN	866	2692	3558	844	2226	3070	97.46	82.69	86.28
21	SIKKIM	0	0	0	0	0	0	***. **	***. **	***. **
22	TAMIL NADU	0	0	0	0	0	0	***. **	***. **	***. **
23	TRIPURA	18	103	121	16	93	109	88.89	90.29	90.08
24	UTTAR PRADESH	0	0	0	0	0	0	***. **	***. **	***. **
25	WEST BENGAL @	0	0	0	0	0	0	***. **	***. **	***. **
26	A & N ISLANDS	0	0	0	0	0	0	***. **	***. **	***. **
27	CHANDIGARH @	29	7	36	26	7	33	89.66	100.00	91.67
28	DADRA & NAGAR HAVELI	0	0	0	0	0	0	***. **	***. **	***. **
29	DAMAN & DIU	0	0	0	0	0	0	***. **	***. **	***. **
30	DELHI	50	282	332	43	222	265	86.00	78.72	79.82
31	LAKSHADWEEP	0	0	0	0	0	0	***. **	***. **	***. **
32	PONDICHEERY	0	0	0	0	0	0	***. **	***. **	***. **
	INDIA	2247	7147	9394	1455	5821	7276	64.75	81.45	77.45

\$ Relates to the year 1986-87

@ Relates to the year 1987-88

TABLE 9.12

POST MATRIC DIPLOMA/CERTIFICATE(Not leading to degree) Non-Affiliated
OTHERS(including Education, Music, Fine Arts, Oriental Studies etc.)

Year : 1988 - 89

S.no.	State/UTs	Number Appeared			Number Passed			Pass Percentage		
		Boys	Girls	Total	Boys	Girls	Total	Boys	Girls	Total
1	2	3	4	5	6	7	8	9	10	11
1	ANDHRA PRADESH	4382	2360	6742	3079	1809	4888	70.26	76.65	72.50
2	ARUNACHAL PRADESH	0	0	0	0	0	0	***. **	***. **	***. **
3	ASSAM	1473	231	1704	1008	160	1168	68.43	69.26	68.54
4	BIHAR	36	7	43	35	7	42	97.22	100.00	97.67
5	GOA	77	220	297	60	191	251	77.92	86.82	84.51
6	GUJARAT	187	121	308	183	119	302	97.86	98.35	98.05
7	HARYANA	404	158	562	297	99	396	73.51	62.66	70.46
8	HIMACHAL PRADESH	915	803	1718	554	742	1296	60.55	92.40	75.44
9	JAMMU & KASHMIR	2040	894	2934	1126	543	1669	55.20	60.74	56.88
10	KARNATAKA	19756	15808	35564	11239	8495	19734	56.89	53.74	55.49
11	KERALA	4600	4544	9144	3355	3472	6827	72.93	76.41	74.66
12	MADHYA PRADESH	0	0	0	0	0	0	***. **	***. **	***. **
13	MAHARASHTRA	0	11	11	0	11	11	***. **	100.00	100.00
14	MANIPUR	56	43	99	38	43	81	67.86	100.00	81.82
15	MEGHALAYA	238	210	448	170	135	305	71.43	64.29	68.08
16	MIZORAM	0	0	0	0	0	0	***. **	***. **	***. **
17	NAGALAND	168	88	256	143	82	225	85.12	93.18	87.89
18	ORISSA	2616	1400	4016	2285	999	3284	87.35	71.36	81.77
19	PUNJAB	330	1698	2028	295	1467	1762	89.39	86.40	86.88
20	RAJASTHAN	4132	1136	5268	3240	926	4166	78.41	81.51	79.08
21	SIKKIM	0	0	0	0	0	0	***. **	***. **	***. **
22	TAMIL NADU	8178	4040	12218	7578	3384	10962	92.66	83.76	89.72
23	TRIPURA	334	154	488	240	127	367	71.86	82.47	75.20
24	UTTAR PRADESH	577	929	1506	533	871	1404	92.37	93.76	93.23
25	WEST BENGAL	0	0	0	0	0	0	***. **	***. **	***. **
26	A & N ISLANDS	23	36	59	23	36	59	100.00	100.00	100.00
27	CHANDIGARH	0	0	0	0	0	0	***. **	***. **	***. **
28	DADRA & NAGAR HAVELI	0	0	0	0	0	0	***. **	***. **	***. **
29	DAMAN & DIU	0	0	0	0	0	0	***. **	***. **	***. **
30	DELHI	836	1048	1884	783	1028	1811	93.66	98.09	96.13
31	LAKSHADWEEP	0	0	0	0	0	0	***. **	***. **	***. **
32	PONDICHERY	0	0	0	0	0	0	***. **	***. **	***. **
INDIA		51358	35939	87297	36264	24746	61010	70.61	68.86	69.89

TABLE 9.13
SCHOOL EDUCATION, MATRICULATION/S.L.C. etc.
Year : 1989 - 90

S.no.	State/UTs	Number Appeared			Number Passed			Pass Percentage		
		Boys	Girls	Total	Boys	Girls	Total	Boys	Girls	Total
1	2	3	4	5	6	7	8	9	10	11
1	ANDHRA PRADESH	784343	297229	1081572	205370	99949	305319	26.18	33.63	28.23
2	ARUNACHAL PRADESH	3180	1429	4609	1207	472	1679	37.96	33.03	36.43
3	ASSAM	160260	123413	283673	61634	34174	95808	38.46	27.69	33.77
4	BIHAR	362959	186979	549938	264130	136067	400197	72.77	72.73	72.77
5	GOA	11930	8805	20735	6209	4612	10821	52.05	52.38	52.19
6	GUJARAT	264929	148508	413437	127469	83055	210524	48.11	55.93	50.92
7	HARYANA	180167	68600	248767	136838	46736	183574	75.95	68.13	73.79
8	HIMACHAL PRADESH	49810	23796	73606	16042	10501	26543	32.21	44.13	36.06
9	JAMMU & KASHMIR	73247	33214	106461	27792	12566	40358	37.94	37.83	37.91
10	KARNATAKA	322861	155271	478132	138588	75549	214137	42.92	48.66	44.79
11	KERALA	235254	280417	515671	113518	122623	236141	48.25	43.73	45.79
12	MADHYA PRADESH @	325732	91082	416814	133030	39733	172763	40.84	43.62	41.45
13	MAHARASHTRA	736862	343206	1080078	281006	160121	441127	38.14	46.65	40.84
14	MANIPUR	16174	16346	32520	6238	4239	10477	38.57	25.93	32.22
15	MEGHALAYA	7430	6544	13974	2672	2039	4711	35.96	31.16	33.71
16	MIZORAM	4462	4044	8506	1498	986	2484	33.57	24.38	29.20
17	NAGALAND	5399	5315	10714	2182	1804	3986	40.41	33.94	37.20
18	ORISSA	127172	77802	204974	64105	33265	97370	50.41	42.76	47.50
19	PUNJAB	208331	90817	299148	146997	49762	196759	70.56	54.79	65.77
20	RAJASTHAN	282201	70476	352677	115503	32515	148018	40.93	46.14	41.97
21	SIKKIM	847	477	1324	503	329	832	59.39	68.97	62.84
22	TAMIL NADU	225160	151599	376759	122944	97986	220930	54.60	64.63	58.64
23	TRIPURA	17210	13570	30780	5106	3922	9028	29.67	28.90	29.33
24	UTTAR PRADESH	1274617	330767	1605384	475051	234640	709691	37.27	70.94	44.21
25	WEST BENGAL @	213088	188965	402053	102746	91114	193860	48.22	48.22	48.22
26	A & N ISLANDS	1871	1450	3321	559	586	1145	29.88	40.41	34.48
27	CHANDIGARH	1950	2027	3977	1428	1522	2950	73.23	75.09	74.18
28	DADRA & NAGAR HAVELI	481	309	790	169	74	243	35.14	23.95	30.76
29	DAMAN & DIU	965	430	1395	451	190	641	46.74	44.19	45.95
30	DELHI	128811	92279	221090	97841	56073	153914	75.96	60.76	69.62
31	LAKSHADWEEP	272	204	476	167	141	308	61.40	69.12	64.71
32	PONDICHEERY	4320	3297	7617	2930	2477	5407	67.82	75.13	70.99
	INDIA	6032295	2818667	8850962	2661923	1439822	4101745	44.13	51.08	46.34

@ Relates to 1988-89

TABLE 9.14

SCHOOL EDUCATION, HIGHER SECONDARY (New pattern 10+2
Old Pattern, Intermediate/Pre-Degree/Pre-University)
Year : 1989 - 90

S.no.	State/UTs	Number Appeared			Number Passed			Pass Percentage		
		Boys	Girls	Total	Boys	Girls	Total	Boys	Girls	Total
1	2	3	4	5	6	7	8	9	10	11
1	ANDHRA PRADESH	352577	130209	482786	66785	36400	103185	18.94	27.96	21.37
2	ARUNACHAL PRADESH	1557	441	1998	710	321	1031	45.60	72.79	51.60
3	ASSAM	93434	46765	140199	30216	16361	46577	32.34	34.99	33.22
4	BIHAR \$	55287	39144	94431	39885	29638	69523	72.14	75.72	73.62
5	GOA	5151	3852	9003	2247	2213	4460	43.62	57.45	49.54
6	GUJARAT	138813	80121	218934	70826	53248	124074	51.02	66.46	56.67
7	HARYANA	54103	19812	73915	23375	11328	34703	43.20	57.18	46.95
8	HIMACHAL PRADESH	18799	9848	28647	4750	6861	11611	25.27	69.67	40.53
9	JAMMU & KASHMIR	16998	13400	30398	9641	6780	16421	56.72	50.60	54.02
10	KARNATAKA	213881	86487	300368	65013	38774	103787	30.40	44.83	34.55
11	KERALA	2935	1768	4703	2824	1697	4521	96.22	95.98	96.13
12	MADHYA PRADESH @	147271	43537	190808	103090	34084	137174	70.00	78.29	71.89
13	MAHARASHTRA	314107	140483	454590	142983	84682	227665	45.52	60.28	50.68
14	MANIPUR	884	465	1349	469	266	735	53.05	57.20	54.48
15	MEGHALAYA	0	0	0	0	0	0	***. **	***. **	***. **
16	MIZORAM	0	0	0	0	0	0	***. **	***. **	***. **
17	NAGALAND	10	2	12	4	1	5	40.00	50.00	41.67
18	ORISSA	115565	40995	156560	35418	15082	50500	30.65	36.79	32.26
19	PUNJAB	77824	37878	115702	38162	20233	58395	49.04	53.42	50.47
20	RAJASTHAN	96543	28123	124666	52644	19535	72179	54.53	69.46	57.90
21	SIKKIM	427	156	583	321	134	455	75.18	85.90	78.04
22	TAMIL NADU	106852	83570	190422	67953	62505	130458	63.60	74.79	68.51
23	TRIPURA	6130	3582	9712	2678	1317	3995	43.69	36.77	41.13
24	UTTAR PRADESH	567600	181633	749233	332944	147320	480264	58.66	81.11	64.10
25	WEST BENGAL @	188320	92754	281074	88307	43495	131802	46.89	46.89	46.89
26	A & N ISLANDS	1089	683	1772	841	409	1250	77.23	59.88	70.54
27	CHANDIGARH	453	804	1257	363	789	1152	80.13	98.13	91.65
28	DADRA & NAGAR HAVELI	224	149	373	118	97	215	52.68	65.10	57.64
29	DAMAN & DIU	398	157	555	178	98	276	44.72	62.42	49.73
30	DELHI	82482	61938	144420	59106	51077	110183	71.66	82.46	76.29
31	LAKSHADWEEP	153	59	212	67	17	84	43.79	28.81	39.62
32	PONDICHERY	1493	1034	2527	1126	811	1937	75.42	78.43	76.65
	INDIA	2661360	1149849	3811209	1243044	685573	1928617	46.71	59.62	50.60

@ Relates to 1988-89

\$ Relates to 1987-88

TABLE 9.15
POST MATRIC DIPLOMA/CERTIFICATE (NOT LEADING TO DEGREE)-NON-AFFILIATED.
COMMERCE/BUSINESS MANAGEMENT
Year : 1989 - 90

S.no.	State/UTs	Number Appeared			Number Passed			Pass Percentage		
		Boys	Girls	Total	Boys	Girls	Total	Boys	Girls	Total
1	2	3	4	5	6	7	8	9	10	11
1	ANDHRA PRADESH	0	0	0	0	0	0	***. **	***. **	***. **
2	ARUNACHAL PRADESH	0	0	0	0	0	0	***. **	***. **	***. **
3	ASSAM	117	48	165	81	29	110	69.23	60.42	66.66
4	BIHAR	0	0	0	0	0	0	***. **	***. **	***. **
5	GOA	74	145	219	29	130	159	39.19	89.66	72.60
6	GUJARAT	0	0	0	0	0	0	***. **	***. **	***. **
7	HARYANA	22	91	113	11	24	35	50.00	26.37	30.97
8	HIMACHAL PRADESH	273	206	479	170	153	323	62.27	74.27	67.43
9	JAMMU & KASHMIR	0	0	0	0	0	0	***. **	***. **	***. **
10	KARNATAKA	0	0	0	0	0	0	***. **	***. **	***. **
11	KERALA	41078	54642	95720	23911	30386	54297	58.21	55.61	56.72
12	MADHYA PRADESH	0	0	0	0	0	0	***. **	***. **	***. **
13	MAHARASHTRA	0	0	0	0	0	0	***. **	***. **	***. **
14	MANIPUR	60	10	70	11	3	14	18.33	30.00	20.00
15	MEGHALAYA	0	0	0	0	0	0	***. **	***. **	***. **
16	MIZORAM	0	0	0	0	0	0	***. **	***. **	***. **
17	NAGALAND	0	0	0	0	0	0	***. **	***. **	***. **
18	ORISSA	0	0	0	0	0	0	***. **	***. **	***. **
19	PUNJAB	1076	621	1697	783	330	1113	72.77	53.14	65.59
20	RAJASTHAN	120	56	176	53	12	65	44.17	21.43	36.93
21	SIKKIM	0	0	0	0	0	0	***. **	***. **	***. **
22	TAMIL NADU	206	320	526	159	174	333	77.18	54.38	63.31
23	TRIPURA	16	2	18	7	1	8	43.75	50.00	44.44
24	UTTAR PRADESH	0	0	0	0	0	0	***. **	***. **	***. **
25	WEST BENGAL	0	0	0	0	0	0	***. **	***. **	***. **
26	A & N ISLANDS	8	31	39	2	8	10	25.00	25.81	25.64
27	CHANDIGARH	0	0	0	0	0	0	***. **	***. **	***. **
28	DADRA & NAGAR HAVELI	0	0	0	0	0	0	***. **	***. **	***. **
29	DAMAN & DIU	0	0	0	0	0	0	***. **	***. **	***. **
30	DELHI	359	154	513	285	120	405	79.39	77.92	78.95
31	LAKSHADWEEP	0	0	0	0	0	0	***. **	***. **	***. **
32	PONDICHERY	19	16	35	3	4	7	15.79	25.00	20.00
INDIA		43428	56342	99770	25505	31374	56879	58.73	55.68	57.01

Relates to the year 1988-89

TABLE 9.16
POST MATRIC DIPLOMA/CERTIFICATE(NOT LEADING TO DEGREE)-NON-AFFILIATED
ENGINEERING/TECHNOLOGY/ARCHITECTURE
Year : 1989 - 90

S.no.	State/UTs	Number Appeared			Number Passed			Pass Percentage		
		Boys	Girls	Total	Boys	Girls	Total	Boys	Girls	Total
1	2	3	4	5	6	7	8	9	10	11
1	ANDHRA PRADESH	43317	3864	47181	24514	2237	26751	56.59	57.89	56.70
2	ARUNACHAL PRADESH	0	0	0	0	0	0	***. **	***. **	***. **
3	ASSAM	2427	205	2632	1709	156	1865	70.42	76.10	70.86
4	BIHAR	0	0	0	0	0	0	***. **	***. **	***. **
5	GOA	1106	82	1188	734	50	784	66.37	60.98	65.99
6	GUJARAT	16963	1700	18663	13426	939	14365	79.15	55.24	76.97
7	HARYANA	11488	3113	14601	8162	1331	9493	71.05	42.76	65.02
8	HIMACHAL PRADESH	499	94	593	370	82	452	74.15	87.23	76.22
9	JAMMU & KASHMIR	529	186	715	221	116	337	41.78	62.37	47.13
10	KARNATAKA	0	0	0	0	0	0	***. **	***. **	***. **
11	KERALA	4865	3404	8269	2869	944	3813	58.97	27.73	46.11
12	MADHYA PRADESH	0	0	0	0	0	0	***. **	***. **	***. **
13	MAHARASHTRA	0	0	0	0	0	0	***. **	***. **	***. **
14	MANIPUR	78	10	88	67	10	77	85.90	100.00	87.50
15	MEGHALAYA	159	24	183	95	12	107	59.75	50.00	58.47
16	MIZORAM	55	14	69	55	14	69	100.00	100.00	100.00
17	NAGALAND	216	124	340	112	55	167	51.85	44.35	49.12
18	ORISSA	5098	282	5380	5004	248	5252	98.16	87.94	97.62
19	PUNJAB	5912	311	6223	2792	227	3019	47.23	72.99	48.51
20	RAJASTHAN	5791	478	6269	3742	403	4145	64.62	84.31	66.12
21	SIKKIM	0	0	0	0	0	0	***. **	***. **	***. **
22	TAMIL NADU	12620	1817	14437	4790	937	5727	37.96	51.57	39.67
23	TRIPURA	176	57	233	164	53	217	93.18	92.98	93.13
24	UTTAR PRADESH	0	0	0	0	0	0	***. **	***. **	***. **
25	WEST BENGAL	0	0	0	0	0	0	***. **	***. **	***. **
26	A & N ISLANDS	69	31	100	41	17	58	59.42	54.84	58.00
27	CHANDIGARH	0	0	0	0	0	0	***. **	***. **	***. **
28	DADRA & NAGAR HAVELI	0	0	0	0	0	0	***. **	***. **	***. **
29	DAMAN & DIU	0	0	0	0	0	0	***. **	***. **	***. **
30	DELHI	5402	1627	7029	4845	1440	6285	89.69	88.51	89.42
31	LAKSHADWEEP	0	0	0	0	0	0	***. **	***. **	***. **
32	PONDICHEERY	99	44	143	46	16	62	46.46	36.36	43.36
INDIA		116869	17467	134336	73758	9287	83045	63.11	53.17	61.82

a Relates to the year 1988-89

TABLE 9.17
POST MATRIC DIPLOMA/CERTIFICATE(NOT LEADING TO DEGREE)-NON-AFFILIATED
MEDICINE/NURSING/PHARMACY/DENTISTRY
Year : 1989 - 90

S.no.	State/UTs	Number Appeared			Number Passed			Pass Percentage		
		Boys	Girls	Total	Boys	Girls	Total	Boys	Girls	Total
1	2	3	4	5	6	7	8	9	10	11
1	ANDHRA PRADESH	0	0	0	0	0	0	***. **	***. **	***. **
2	ARUNACHAL PRADESH	0	0	0	0	0	0	***. **	***. **	***. **
3	ASSAM	0	0	0	0	0	0	***. **	***. **	***. **
4	BIHAR	0	0	0	0	0	0	***. **	***. **	***. **
5	GOA	40	61	101	25	56	81	62.50	91.80	80.20
6	GUJARAT	50	1032	1082	45	604	649	90.00	58.53	59.98
7	HARYANA	220	753	973	82	725	807	37.27	96.28	82.94
8	HIMACHAL PRADESH	0	0	0	0	0	0	***. **	***. **	***. **
9	JAMMU & KASHMIR	0	0	0	0	0	0	***. **	***. **	***. **
10	KARNATAKA	0	0	0	0	0	0	***. **	***. **	***. **
11	KERALA	300	1516	1816	77	1265	1342	25.67	83.44	73.90
12	MADHYA PRADESH	0	0	0	0	0	0	***. **	***. **	***. **
13	MAHARASHTRA	0	0	0	0	0	0	***. **	***. **	***. **
14	MANIPUR	0	61	61	0	55	55	***. **	90.16	90.16
15	MEGHALAYA	0	0	0	0	0	0	***. **	***. **	***. **
16	MIZORAM	0	0	0	0	0	0	***. **	***. **	***. **
17	NAGALAND	0	0	0	0	0	0	***. **	***. **	***. **
18	ORISSA	0	0	0	0	0	0	***. **	***. **	***. **
19	PUNJAB	143	1839	1982	56	1654	1710	39.16	89.94	86.28
20	RAJASTHAN	47	990	1037	16	853	869	34.04	86.16	83.80
21	SIKKIM	0	0	0	0	0	0	***. **	***. **	***. **
22	TAMIL NADU	331	726	1057	299	636	935	90.33	87.60	88.46
23	TRIPURA	33	178	211	23	161	184	69.70	90.45	87.20
24	UTTAR PRADESH	0	0	0	0	0	0	***. **	***. **	***. **
25	WEST BENGAL	0	0	0	0	0	0	***. **	***. **	***. **
26	A & M ISLANDS	0	0	0	0	0	0	***. **	***. **	***. **
27	CHANDIGARH	0	0	0	0	0	0	***. **	***. **	***. **
28	DADRA & NAGAR HAVELI	0	0	0	0	0	0	***. **	***. **	***. **
29	DAHAN & DIU	0	0	0	0	0	0	***. **	***. **	***. **
30	DELHI	50	306	356	48	248	296	96.00	81.05	83.15
31	LAKSHADWEEP	0	0	0	0	0	0	***. **	***. **	***. **
32	PONDICHERY	0	0	0	0	0	0	***. **	***. **	***. **
	INDIA	1214	7462	8676	671	6257	6928	55.27	83.85	79.85

Relates to the year 1988-89

TABLE 9.18

POST MATRIC DIPLOMA/CERTIFICATE(NOT LEADING TO DEGREE)-NON-AFFILIATED
OTHERS(INCLUDING EDUCATION,MUSIC & FINE ARTS,ORIENTAL STUDIES etc.

Year : 1989 - 90

S.no.	State/UTs	Number Appeared			Number Passed			Pass Percentage		
		Boys	Girls	Total	Boys	Girls	Total	Boys	Girls	Total
1	2	3	4	5	6	7	8	9	10	11
1	ANDHRA PRADESH	1077	908	1985	507	556	1063	47.08	61.23	53.55
2	ARUNACHAL PRADESH	0	0	0	0	0	0	***. **	***. **	***. **
3	ASSAM	1525	426	1951	1182	280	1462	77.51	65.73	74.94
4	BIHAR	19	20	39	13	17	30	68.42	85.00	76.92
5	GOA	8	83	91	4	63	67	50.00	75.90	73.63
6	GUJARAT	51	68	119	51	68	119	100.00	100.00	100.00
7	HARYANA	338	136	474	247	80	327	73.08	58.82	68.99
8	HIMACHAL PRADESH	1010	770	1780	582	721	1303	57.62	93.64	73.20
9	JAMMU & KASHMIR	2423	971	3394	1239	572	1811	51.13	58.91	53.36
10	KARNATAKA	11620	10561	22181	7131	5673	12804	61.37	53.72	57.73
11	KERALA	2876	3315	6191	2640	2903	5543	91.79	87.57	89.55
12	MADHYA PRADESH @	0	0	0	0	0	0	***. **	***. **	***. **
13	MAHARASHTRA	0	7	7	0	7	7	***. **	100.00	100.00
14	MANIPUR	104	70	174	70	68	138	67.31	97.14	79.31
15	MEGHALAYA	240	213	453	175	137	312	72.92	64.32	68.87
16	MIZORAM	0	0	0	0	0	0	***. **	***. **	***. **
17	NAGALAND	65	25	90	57	23	80	87.69	92.00	88.89
18	ORISSA	1549	1329	2878	1429	1248	2677	92.25	93.91	93.02
19	PUNJAB	473	903	1376	442	764	1206	93.45	84.61	87.65
20	RAJASTHAN	2728	1660	4388	2545	1417	3962	93.29	85.36	90.29
21	SIKKIM	0	0	0	0	0	0	***. **	***. **	***. **
22	TAMIL NADU	17796	3718	21514	13111	2814	15925	73.67	75.69	74.02
23	TRIPURA	211	101	312	157	63	220	74.41	62.38	70.51
24	UTTAR PRADESH	622	938	1560	503	885	1388	80.87	94.35	88.97
25	WEST BENGAL @	0	0	0	0	0	0	***. **	***. **	***. **
26	A & N ISLANDS	27	39	66	27	39	66	100.00	100.00	100.00
27	CHANDIGARH	0	0	0	0	0	0	***. **	***. **	***. **
28	DADRA & NAGAR HAVELI	0	0	0	0	0	0	***. **	***. **	***. **
29	DAMAN & DIU	0	0	0	0	0	0	***. **	***. **	***. **
30	DELHI	438	929	1367	389	866	1255	88.81	93.22	91.81
31	LAKSHADWEEP	0	0	0	0	0	0	***. **	***. **	***. **
32	PONDICHEERY	0	0	0	0	0	0	***. **	***. **	***. **
INDIA		45200	27190	72390	32501	19264	51765	71.90	70.85	71.51

@ Relates to the year 1988-89

TABLE 9.19
SCHOOL EDUCATION, MATRICULATION/ S.L.C. etc.
Year : 1990 - 91

S.no.	State/UTs	Number Appeared			Number Passed			Pass Percentage		
		Boys	Girls	Total	Boys	Girls	Total	Boys	Girls	Total
1	2	3	4	5	6	7	8	9	10	11
1	ANDHRA PRADESH	796327	306302	1102629	233691	113813	347504	29.35	37.16	31.52
2	ARUNACHAL PRADESH	3507	1228	4735	1508	633	2141	43.00	51.55	45.22
3	ASSAM	199655	162078	361733	67203	38059	105262	33.66	23.48	29.10
4	BIHAR	562942	62448	625390	363247	40360	403607	64.53	64.63	64.54
5	GOA	11502	9315	20817	5594	4477	10071	48.64	48.06	48.38
6	GUJARAT	280382	157148	437530	162542	102592	265134	57.97	65.28	60.60
7	HARYANA @	180167	68600	248767	136838	46736	183574	75.95	68.13	73.79
8	HIMACHAL PRADESH	53369	29922	83291	27227	15301	42528	51.02	51.14	51.06
9	JAMMU & KASHMIR *	48880	24702	73582	14546	7782	22328	29.76	31.50	30.34
10	KARNATAKA	415698	202426	618124	199294	111050	310344	47.94	54.86	50.21
11	KERALA	262080	293342	555422	133626	154927	288553	50.99	52.81	51.95
12	MADHYA PRADESH @	390565	114003	504568	156090	51745	207835	39.97	45.39	41.19
13	MAHARASHTRA	761303	361644	1122947	325198	181886	507084	42.72	50.29	45.16
14	MANIPUR	26614	23269	498883	11106	8319	19425	41.73	35.75	3.89
15	MEGHALAYA	7863	7048	14911	2378	1802	4180	30.24	25.57	28.03
16	MIZORAM	4144	5148	9292	1583	1160	2743	38.20	22.53	29.52
17	NAGALAND	6235	3570	98805	2496	1773	4269	40.03	49.66	4.32
18	ORISSA	151117	115094	266211	74515	36291	110806	49.31	31.53	41.62
19	PUNJAB	246870	72035	318905	154215	44929	199144	62.47	62.37	62.45
20	RAJASTHAN	306012	78216	384228	123142	34892	158034	40.24	44.61	41.13
21	SIKKIM	1212	809	2021	550	348	898	45.38	43.02	44.43
22	TAMIL NADU	244541	172919	417460	140582	114182	254764	57.49	66.03	61.03
23	TRIPURA	18905	13690	32595	5259	3808	9067	27.82	27.82	27.82
24	UTTAR PRADESH	1332617	357980	1690597	702234	278985	981219	52.70	77.93	58.04
25	WEST BENGAL @	249190	220980	470170	124583	110479	235062	50.00	50.00	50.00
26	A & N ISLANDS	1482	1251	2733	638	484	1122	43.05	38.69	41.05
27	CHANDIGARH	3680	3480	7160	2857	2618	5475	77.64	75.23	76.47
28	DADRA & NAGAR HAVELI	449	239	688	247	133	380	55.01	55.65	55.23
29	DAMAN & DIU	660	477	1137	374	278	652	56.67	58.28	57.34
30	DELHI	NA	NA	NA	NA	NA	NA	***.***	***.***	***.***
31	LAKSHADWEEP	223	154	377	168	119	287	75.34	77.27	76.13
32	PONDICHEERY	4004	4018	8022	3016	3347	6363	75.32	83.30	79.32
INDIA		6572195	2873535	9983730	3176547	1513308	4689855	48.33	52.66	46.97

@ Relates to the year 1989-90

* Pertains to Jammu Province Only. No examination in Kashmir Division during the year.

NA Figures not available.

TABLE 9.20
SCHOOL EDUCATION, HIGHER SECONDARY(New Pattern 10+2,
OLD PATTERN, INTERMEDIATE/PRE-DEGREE/PRE-UNIVERSITY
Year : 1990 - 91

S.no.	State/UTs	Number Appeared			Number Passed			Pass Percentage		
		Boys	Girls	Total	Boys	Girls	Total	Boys	Girls	Total
1	2	3	4	5	6	7	8	9	10	11
1	ANDHRA PRADESH	298	203	501	266	189	455	89.26	93.10	90.82
2	ARUNACHAL PRADESH	2103	679	2782	864	349	1213	41.08	51.40	43.60
3	ASSAM	90573	52645	143218	37932	19814	57746	41.88	37.64	40.32
4	BIHAR	197717	137397	335114	53484	40348	93832	27.05	29.37	28.00
5	GOA	5304	4434	9738	3021	2902	5923	56.96	65.45	60.82
6	GUJARAT	142022	80999	223021	66981	51790	118771	47.16	63.94	53.26
7	HARYANA @	54103	19812	73915	23375	11328	34703	43.20	57.18	46.95
8	HIMACHAL PRADESH	19411	8412	27823	5357	3320	8677	27.60	39.47	31.19
9	JAMMU & KASHMIR *	28551	23407	51958	14296	11169	25465	50.07	47.72	49.01
10	KARNATAKA	310566	126076	436642	83412	49980	133392	26.86	39.64	30.55
11	KERALA	1409	835	2244	1339	760	2099	95.03	91.02	93.54
12	MADHYA PRADESH	225822	63425	289247	143044	44966	188010	63.34	70.90	65.00
13	MAHARASHTRA	325325	143324	468649	148466	86168	234634	45.64	60.12	50.06
14	MANIPUR	1151	426	1577	864	307	1171	75.07	72.07	74.25
15	MEGHALAYA	0	0	0	0	0	0	***. **	***. **	***. **
16	MIZORAM	0	0	0	0	0	0	***. **	***. **	***. **
17	NAGALAND	27	9	36	18	4	22	66.67	44.44	61.11
18	ORISSA	106831	41176	148007	43339	18302	61641	40.57	44.45	41.65
19	PUNJAB	75734	39050	114784	48630	24004	72634	64.21	61.47	63.28
20	RAJASTHAN	155933	38795	194728	80354	24965	105319	51.53	64.35	54.09
21	SIKKIM	603	275	878	343	171	514	56.88	62.18	58.54
22	TAMIL NADU	112932	91843	204775	66316	64221	130537	58.72	69.92	63.75
23	TRIPURA	6865	3536	10401	2783	1434	4217	40.54	40.55	40.54
24	UTTAR PRADESH	595512	201592	797104	468503	173560	642063	78.67	86.09	80.55
25	WEST BENGAL \$	206561	101739	308300	80462	39631	120093	38.95	38.95	38.95
26	A & N ISLANDS	745	614	1359	462	399	861	62.01	64.98	63.36
27	CHANDIGARH	1246	1170	2416	849	937	1786	68.14	80.09	73.92
28	DADRA & NAGAR HAVELI	181	121	302	119	77	196	65.75	63.64	64.90
29	DAMAN & DIU	402	181	583	149	91	240	37.06	50.28	41.17
30	DELHI +	NA	NA	NA	NA	NA	NA	** **	*** **	*** **
31	LAKSHADWEEP	129	62	191	35	28	63	27.13	45.16	32.98
32	PONDICHERY	1563	1412	2975	1115	956	2071	71.34	67.71	69.61
INDIA		2669619	1183649	3853268	1376178	672170	2048348	51.55	56.79	53.15

@ Relates to the year 1989-90

* Pertains to Jammu Province Only. No examination in Kashmir Division during the year.

\$ Relates to the year 1988-89

+ Figures not available.

TABLE 9.21
POST-MATRIC DIPLOMA/CERTIFICATE (NOT LEADING TO DEGREE) NON-AFFILIATED
COMMERCE/BUSINESS MANAGEMENT
Year : 1990 - 91

S.no.	State/UTs	Number Appeared			Number Passed			Pass Percentage		
		Boys	Girls	Total	Boys	Girls	Total	Boys	Girls	Total
1	2	3	4	5	6	7	8	9	10	11
1	ANDHRA PRADESH	0	0	0	0	0	0	***. **	***. **	***. **
2	ARUNACHAL PRADESH	0	0	0	0	0	0	***. **	***. **	***. **
3	ASSAM	120	53	173	86	30	116	71.67	56.60	67.05
4	BIHAR	0	0	0	0	0	0	***. **	***. **	***. **
5	GOA	38	84	122	22	14	36	57.89	16.67	29.51
6	GUJARAT	0	0	0	0	0	0	***. **	***. **	***. **
7	HARYANA	65	21	86	46	11	57	70.77	52.38	66.28
8	HIMACHAL PRADESH	192	220	412	115	161	276	59.90	73.18	66.99
9	JAMMU & KASHMIR	0	0	0	0	0	0	***. **	***. **	***. **
10	KARNATAKA	60714	81131	141845	29163	46695	75858	48.03	57.56	53.48
11	KERALA	41078	54642	95720	23911	30386	54297	58.21	55.61	56.72
12	MADHYA PRADESH	0	0	0	0	0	0	***. **	***. **	***. **
13	MAHARASHTRA	0	0	0	0	0	0	***. **	***. **	***. **
14	MANIPUR	63	12	75	14	5	19	22.22	41.67	25.33
15	MEGHALAYA	0	0	0	0	0	0	***. **	***. **	***. **
16	MIZORAM	0	0	0	0	0	0	***. **	***. **	***. **
17	NAGALAND	0	0	0	0	0	0	***. **	***. **	***. **
18	ORISSA	0	0	0	0	0	0	***. **	***. **	***. **
19	PUNJAB	1062	619	1681	711	321	1032	66.95	51.86	61.39
20	RAJASTHAN	125	12	137	72	12	84	57.60	100.00	61.31
21	SIKKIM	0	0	0	0	0	0	***. **	***. **	***. **
22	TAMIL NADU	264	35	299	180	30	210	68.18	85.71	70.23
23	TRIPURA	19	11	30	8	7	15	42.11	63.64	50.00
24	UTTAR PRADESH	0	0	0	0	0	0	***. **	***. **	***. **
25	WEST BENGAL	0	0	0	0	0	0	***. **	***. **	***. **
26	A & N ISLANDS	8	16	24	3	9	12	37.50	56.25	50.00
27	CHANDIGARH	0	0	0	0	0	0	***. **	***. **	***. **
28	DADRA & NAGAR HAVELI	0	0	0	0	0	0	***. **	***. **	***. **
29	DAMAN & DIU	0	0	0	0	0	0	***. **	***. **	***. **
30	DELHI	361	155	516	291	127	418	80.61	81.94	81.01
31	LAKSHADWEEP	0	0	0	0	0	0	***. **	***. **	***. **
32	PONDICHERY	7	23	30	0	16	16	0.00	69.57	53.33
INDIA		104116	137034	241150	54622	77824	132446	52.46	56.79	54.92

2 Relates to the year 1989-90

TABLE 9.22
POST-MATRIC DIPLOMA/CERTIFICATE (NOT LEADING TO DEGREE) NON-AFFILIATED
ENGINEERING/TECHNOLOGY/ARCHITECTURE
Year : 1990 - 91

S.no.	State/UTs	Number Appeared			Number Passed			Pass Percentage		
		Boys	Girls	Total	Boys	Girls	Total	Boys	Girls	Total
1	2	3	4	5	6	7	8	9	10	11
1	ANDHRA PRADESH	29406	2357	31763	18791	1473	20264	63.90	62.49	63.80
2	ARUNACHAL PRADESH	0	0	0	0	0	0	***.***	***.***	***.***
3	ASSAM	2886	225	3111	1795	172	1967	62.20	76.44	63.23
4	BIHAR	0	0	0	0	0	0	***.***	***.***	***.***
5	GOA	2390	248	2638	1642	161	1803	68.70	64.92	68.35
6	GUJARAT @	16963	1700	18663	13426	939	14365	79.15	55.24	66.97
7	HARYANA	12390	3379	15769	8683	1431	10114	70.08	42.35	64.14
8	HIMACHAL PRADESH	1480	943	2423	904	794	1698	61.08	84.20	70.08
9	JAMMU & KASHMIR	2001	708	2709	1017	466	1483	50.82	65.82	54.74
10	KARNATAKA	0	0	0	0	0	0	***.***	***.***	***.***
11	KERALA	2608	1382	3990	1994	1004	2998	76.46	72.65	75.14
12	MADHYA PRADESH	0	0	0	0	0	0	***.***	***.***	***.***
13	MAHARASHTRA	0	0	0	0	0	0	***.***	***.***	***.***
14	MANIPUR	90	18	108	71	3	74	78.89	16.67	68.52
15	MEGHALAYA	238	34	272	48	5	53	20.17	14.71	19.49
16	MIZORAM *	55	14	69	55	14	69	100.00	100.00	100.00
17	NAGALAND	82	1	83	82	1	83	100.00	100.00	100.00
18	ORISSA	4801	274	5075	4570	233	4803	95.19	85.04	94.64
19	PUNJAB	4850	238	5088	3079	70	3149	63.48	29.41	61.89
20	RAJASTHAN	7295	673	7968	4967	533	5500	68.09	79.20	69.03
21	SIKKIM	0	0	0	0	0	0	***.***	***.***	***.***
22	TAMIL NADU	18015	2949	20964	9225	2012	11237	51.21	68.23	53.60
23	TRIPURA	176	34	210	158	32	190	89.77	94.12	90.48
24	UTTAR PRADESH	0	0	0	0	0	0	***.***	***.***	***.***
25	WEST BENGAL	0	0	0	0	0	0	***.***	***.***	***.***
26	A & N ISLANDS	87	36	123	58	23	81	66.67	63.89	65.85
27	CHANDIGARH	0	0	0	0	0	0	***.***	***.***	***.***
28	DADRA & NAGAR HAVELI	0	0	0	0	0	0	***.***	***.***	***.***
29	DAMAN & DIU	140	13	153	96	13	109	68.57	100.00	71.24
30	DELHI	5407	1637	7044	4848	1444	6292	89.66	88.21	89.32
31	LAKSHADWEEP	0	0	0	0	0	0	***.***	***.***	***.***
32	PONDICHERY	123	104	227	75	73	148	60.98	70.19	65.20
INDIA		111483	16967	128450	75584	10896	86480	67.80	64.22	67.33

@ Relates to the year 1988-89

* Relates to the year 1989-90

TABLE 9.23

POST-NATRIC DIPLOMA/CERTIFICATE (NOT LEADING TO DEGREE) NON-AFFILIATED
MEDICINE/NURSING/PHARMACY/DENTISTRY

Year : 1990 - 91

S.no.	State/UTs	Number Appeared			Number Passed			Pass Percentage		
		Boys	Girls	Total	Boys	Girls	Total	Boys	Girls	Total
1	2	3	4	5	6	7	8	9	10	11
1	ANDHRA PRADESH	0	0	0	0	0	0	***. **	***. **	***. **
2	ARUNACHAL PRADESH	0	0	0	0	0	0	***. **	***. **	***. **
3	ASSAM	0	0	0	0	0	0	***. **	***. **	***. **
4	BIHAR	0	0	0	0	0	0	***. **	***. **	***. **
5	GOA	40	68	108	22	62	84	55.00	91.18	77.78
6	GUJARAT	106	663	769	97	555	652	91.51	83.71	84.79
7	HARYANA	989	285	1274	592	190	782	59.86	66.67	61.38
8	HIMACHAL PRADESH	0	0	0	0	0	0	***. **	***. **	***. **
9	JAMMU & KASHMIR	0	0	0	0	0	0	***. **	***. **	***. **
10	KARNATAKA	0	0	0	0	0	0	***. **	***. **	***. **
11	KERALA	330	723	1053	96	438	534	29.09	60.58	50.71
12	MADHYA PRADESH	0	0	0	0	0	0	***. **	***. **	***. **
13	MAHARASHTRA	101	43	144	89	39	128	88.12	90.70	88.89
14	MANIPUR	0	68	68	0	59	59	***. **	86.76	86.76
15	MEGHALAYA	0	0	0	0	0	0	***. **	***. **	***. **
16	MIZORAM	0	0	0	0	0	0	***. **	***. **	***. **
17	NAGALAND	0	0	0	0	0	0	***. **	***. **	***. **
18	ORISSA	0	0	0	0	0	0	***. **	***. **	***. **
19	PUNJAB	78	1179	1257	25	1049	1074	32.05	88.97	85.44
20	RAJASTHAN	267	857	1124	161	747	908	60.30	87.16	80.78
21	SIKKIM	0	0	0	0	0	0	***. **	***. **	***. **
22	TAMIL NADU	310	1310	1620	292	1207	1499	94.19	92.14	92.53
23	TRIPURA	47	105	152	40	99	139	85.11	94.29	91.45
24	UTTAR PRADESH	0	0	0	0	0	0	***. **	***. **	***. **
25	WEST BENGAL \$	0	0	0	0	0	0	***. **	***. **	***. **
26	A & N ISLANDS	0	0	0	0	0	0	***. **	***. **	***. **
27	CHANDIGARH	0	0	0	0	0	0	***. **	***. **	***. **
28	DADRA & NAGAR HAVELI	0	0	0	0	0	0	***. **	***. **	***. **
29	DAMAN & DIU	0	0	0	0	0	0	***. **	***. **	***. **
30	DELHI	50	311	361	45	255	300	90.00	81.99	83.10
31	LAKSHADWEEP	0	0	0	0	0	0	***. **	***. **	***. **
32	PONDICHERY	0	49	49	0	47	47	***. **	95.92	95.92
INDIA		2318	5661	7979	1459	4747	6206	62.94	83.85	77.78

\$ Relates to the year 1988-89

TABLE 9.24

POST-MATRIC DIPLOMA/CERTIFICATE (NOT LEADING TO DEGREE) NON-AFFILIATED
OTHERS(INCLUDING EDUCATION, MUSIC & FINE ARTS, ORIENTAL STUDIES etc.)

Year : 1990 - 91

S.no.	State/UTs	Number Appeared			Number Passed			Pass Percentage		
		Boys	Girls	Total	Boys	Girls	Total	Boys	Girls	Total
1	2	3	4	5	6	7	8	9	10	11
1	ANDHRA PRADESH	2592	1619	4211	2190	1440	3630	84.49	88.94	86.20
2	ARUNACHAL PRADESH	0	0	0	0	0	0	***. **	***. **	***. **
3	ASSAM	1670	438	2108	706	184	890	42.28	42.01	42.22
4	BIHAR	739	158	897	550	100	650	74.42	63.29	72.46
5	GOA	11	45	56	11	45	56	100.00	100.00	100.00
6	GUJARAT	13313	1191	14504	10010	904	10914	75.19	75.90	75.25
7	HARYANA	22	66	88	7	51	58	31.82	77.27	65.91
8	HIMACHAL PRADESH	0	0	0	0	0	0	***. **	***. **	***. **
9	JAMMU & KASHMIR	435	273	708	292	169	461	67.13	61.90	65.11
10	KARNATAKA	12605	11135	23740	796	6061	6857	6.31	54.43	28.88
11	KERALA	32755	49875	82630	19677	31357	51034	60.07	62.87	61.76
12	MADHYA PRADESH	0	0	0	0	0	0	***. **	***. **	***. **
13	MAHARASHTRA	0	3	3	0	3	3	***. **	100.00	100.00
14	MANIPUR	71	46	117	46	32	78	64.79	69.57	66.67
15	MEGHALAYA	241	215	456	177	140	317	73.44	65.12	69.52
16	MIZORAM	0	0	0	0	0	0	***. **	***. **	***. **
17	NAGALAND	77	38	115	72	31	103	93.51	81.58	89.57
18	ORISSA	1559	1352	2911	1520	1255	2775	97.50	92.83	95.33
19	PUNJAB	108	548	656	96	465	561	88.89	84.85	85.52
20	RAJASTHAN	3814	2478	6292	3107	1883	4990	81.46	75.99	79.31
21	SIKKIM	0	0	0	0	0	0	***. **	***. **	***. **
22	TAMIL NADU	18729	3062	21791	13430	2101	15531	71.71	68.62	71.27
23	TRIPURA	252	88	340	190	64	254	75.40	72.73	74.71
24	UTTAR PRADESH	708	1049	1757	594	941	1535	83.90	89.70	87.36
25	WEST BENGAL \$	0	0	0	0	0	0	***. **	***. **	***. **
26	A & N ISLANDS	32	35	67	26	19	45	81.25	54.29	67.16
27	CHANDIGARH	0	0	0	0	0	0	***. **	***. **	***. **
28	DADRA & NAGAR HAVELI	0	0	0	0	0	0	***. **	***. **	***. **
29	DAMAN & DIU	0	0	0	0	0	0	***. **	***. **	***. **
30	DELHI	439	972	1411	398	954	1352	90.66	98.15	95.82
31	LAKSHADWEEP	0	0	0	0	0	0	***. **	***. **	***. **
32	PONDICHERY	0	0	0	0	0	0	***. **	***. **	***. **
INDIA		90172	74686	164858	53895	48199	102094	59.77	64.54	61.93

\$ Relates to the year 1988-89

TABLE 9.25 : SCHOOL EXAMINATION RESULTS 1991 - 92
MATRICULATION/SLC

S.no.	State/UTs	Number Appeared			Number Passed			Pass Percentage		
		Boys	Girls	Total	Boys	Girls	Total	Boys	Girls	Total
1	2	3	4	5	6	7	8	9	10	11
1	ANDHRA PRADESH	822614	332814	1155428	235488	116924	352412	28.63	35.13	30.50
2	ARUNACHAL PRADESH	3693	1639	5332	1366	648	2014	36.99	39.54	37.77
3	ASSAM	199655	162078	361733	67203	38059	105262	33.66	23.48	29.10
4	BIHAR	451385	193449	644834	290590	156470	447060	64.38	80.88	69.33
5	GOA	13488	10706	24194	6783	5819	12602	50.29	54.35	52.09
6	GUJARAT	279677	162012	441689	181676	119492	301168	64.96	73.76	68.19
7	HARYANA	180167	68600	248767	136838	46736	183574	75.95	68.13	73.79
8	HIMACHAL PRADESH	57195	37290	94485	21102	13331	34433	36.89	35.75	36.44
9	JAMMU & KASHMIR	69289	34431	103720	13148	6012	19160	18.98	17.46	18.47
10	KARNATAKA	439450	223953	663403	204762	114718	319480	46.60	51.22	48.16
11	KERALA	265239	263813	529052	136535	133376	269911	51.48	50.56	51.02
12	MADHYA PRADESH	325732	91082	416814	133030	39733	172763	40.84	43.62	41.45
13	MAHARASHTRA	779852	386140	1165992	312254	186596	498850	40.04	48.32	42.78
14	MANIPUR	35162	9981	45143	9546	3871	13417	27.15	38.78	29.72
15	MEGHALAYA	7978	8861	16839	2420	2289	4709	30.33	25.83	27.96
16	MIZORAM	3051	3231	6282	1429	1328	2757	46.84	41.10	43.89
17	NAGALAND	6553	4081	10634	2578	1723	4301	39.34	42.22	40.45
18	ORISSA	151117	115094	266211	74515	36291	110806	49.31	31.53	41.62
19	PUNJAB	233191	93554	326745	106881	40022	146903	45.83	42.78	44.96
20	RAJASTHAN	312534	86611	399145	118139	38334	156473	37.80	44.26	39.20
21	SIKKIM	1390	927	2317	588	372	960	42.30	40.13	41.43
22	TAMIL NADU	267228	194248	461476	176708	144632	321340	66.13	74.46	69.63
23	TRIPURA	21271	15404	36675	6602	4789	11391	31.04	31.09	31.06
24	UTTAR PRADESH	1220272	349656	1569928	103419	127432	230851	8.48	36.44	14.70
25	WEST BENGAL	246310	218426	464736	149822	132861	282683	60.83	60.83	60.83
26	A & N ISLANDS	1567	1399	2966	867	710	1577	55.33	50.75	53.17
27	CHANDIGARH	3748	3322	7070	2758	2365	5123	73.59	71.19	72.46
28	DADRA & NAGAR HAVELI	484	280	764	260	157	417	53.72	56.07	54.58
29	DAMAN & DIU	931	761	1692	376	312	688	40.39	41.00	40.66
30	DELHI	88405	65261	153666	36963	35335	72298	41.81	54.14	47.05
31	LAKSHADWEEP	223	154	377	168	119	287	75.34	77.27	76.13
32	PONDICHERRY	3936	3407	7343	3043	2839	5882	77.31	83.33	80.10
INDIA		6492787	3142665	9635452	2537857	1553695	4091552	39.09	49.44	42.46

@ Data relates to 1990-91

+ Data relates to 1989-90

\$ Data relates to 1988-89

TABLE 9.26 : SCHOOL EXAMINATION RESULTS 1991 - 92
HIGHER SECONDARY (10+2 PATTERN)

S.no.	State/UTs	Number Appeared			Number Passed			Pass Percentage		
		Boys	Girls	Total	Boys	Girls	Total	Boys	Girls	Total
1	2	3	4	5	6	7	8	9	10	11
1	ANDHRA PRADESH	247	179	426	226	176	402	91.50	98.32	94.37
2	ARUNACHAL PRADESH	2211	678	2889	1223	372	1595	55.31	54.87	55.21
3	ASSAM	90573	52645	143218	37932	19814	57746	41.88	37.64	40.32
4	BIHAR	39867	24911	64778	29993	17496	47489	75.23	70.23	73.31
5	GOA	6052	5236	11288	3015	3032	6047	49.82	57.91	53.57
6	GUJARAT	148459	85723	234182	99547	69687	169234	67.05	81.29	72.27
7	HARYANA	54103	19812	73915	23375	11328	34703	43.20	57.18	46.95
8	HIMACHAL PRADESH	19939	10618	30557	7092	4406	11498	35.57	41.50	37.63
9	JAMMU & KASHMIR	44398	40127	84525	13253	11208	24461	29.85	27.93	28.94
10	KARNATAKA	352430	140740	493170	88493	52075	140568	25.11	37.00	28.50
11	KERALA	6182	4433	10615	3741	2658	6399	60.51	59.96	60.28
12	MADHYA PRADESH	212784	62199	274983	115695	40479	156174	54.37	65.08	56.79
13	MAHARASHTRA	366411	177569	543980	162036	106260	268296	44.22	59.84	49.32
14	MANIPUR	1341	670	2011	749	435	1184	55.85	64.93	58.88
15	MEGHALAYA	-	-	-	-	-	-	-	-	-
16	MIZORAM	-	-	-	-	-	-	-	-	-
17	NAGALAND	-	-	-	-	-	-	-	-	-
18	ORISSA	106831	41176	148007	43339	18302	61641	40.57	44.45	41.65
19	PUNJAB	104513	32801	137314	47462	16097	63559	45.41	49.07	46.29
20	RAJASTHAN	166139	45441	211580	71566	26741	98307	43.08	58.85	46.46
21	SIKKIM	632	288	920	411	205	616	65.03	71.18	66.96
22	TAMIL NADU	128270	106056	234326	87365	82556	169921	68.11	77.84	72.51
23	TRIPURA	6991	3602	10593	2915	1501	4416	41.70	41.67	41.69
24	UTTAR PRADESH	502789	193698	696487	114614	96994	211608	22.80	50.07	30.38
25	WEST BENGAL	195300	96192	291492	76424	37642	114066	39.13	39.13	39.13
26	A & N ISLANDS	858	698	1556	624	558	1182	72.73	79.94	75.96
27	CHANDIGARH	1778	2244	4022	1322	1858	3180	74.35	82.80	79.07
28	DADRA & NAGAR HAVELI	226	140	366	136	107	243	60.18	76.43	66.39
29	DAHANU & DIU	343	179	522	150	100	250	43.73	55.87	47.89
30	DELHI	46687	40190	86877	24492	27331	51823	52.46	68.00	59.65
31	LAKSHADWEEP	129	62	191	35	28	63	27.13	45.16	32.98
32	PONDICHERRY	1741	1546	3287	1348	1187	2535	77.43	76.78	77.12
INDIA		2608224	1189853	3798077	1058573	650633	1709206	40.59	54.68	45.00

@ Data relates to 1990-91

+ Data relates to 1989-90

\$ Data relates to 1988-89

Include High Secondary (Old Pattern)
Intermediate/Pre-degree/Pre-university

TABLE 9.27 : POST MATRIC DIPLOMA/CERTIFICATE(NOT LEADING TO DEGREE)-NON -AFFILIATED
COMMERCE/BUSINESS MANAGEMENT
YEAR 1991 - 92

S.no.	State/UTs	Number Appeared			Number Passed			Pass Percentage		
		Boys	Girls	Total	Boys	Girls	Total	Boys	Girls	Total
1	2	3	4	5	6	7	8	9	10	11
1	ANDHRA PRADESH	-	-	-	-	-	-	-	-	-
2	ARUNACHAL PRADESH	-	-	-	-	-	-	-	-	-
3	ASSAM	120	53	173	86	30	116	71.67	56.60	67.05
4	BIHAR	-	-	-	-	-	-	-	-	-
5	GOA	58	124	182	32	37	69	55.17	29.84	37.91
6	GUJARAT	-	-	-	-	-	-	-	-	-
7	HARYANA	9	-	9	5	-	5	55.56	-	55.56
8	HIMACHAL PRADESH	164	214	378	56	99	155	34.15	46.26	41.01
9	JAMMU & KASHMIR	-	-	-	-	-	-	-	-	-
10	KARNATAKA	53840	72106	125946	25786	41357	67143	47.89	57.36	53.31
11	KERALA	30480	46957	77437	18474	23625	42099	60.61	50.31	54.37
12	MADHYA PRADESH	-	-	-	-	-	-	-	-	-
13	MAHARASHTRA	-	-	-	-	-	-	-	-	-
14	MANIPUR	68	18	86	17	7	24	25.00	38.89	27.91
15	MEGHALAYA	-	-	-	-	-	-	-	-	-
16	MIZORAM	-	-	-	-	-	-	-	-	-
17	NAGALAND	-	-	-	-	-	-	-	-	-
18	ORISSA	-	-	-	-	-	-	-	-	-
19	PUNJAB	1115	545	1660	633	289	922	56.77	53.03	55.54
20	RAJASTHAN	71	4	75	54	4	58	76.06	100.00	77.33
21	SIKKIM	-	-	-	-	-	-	-	-	-
22	TAMIL NADU	44	13	57	34	12	46	77.27	92.31	80.70
23	TRIPURA	-	-	-	-	-	-	-	-	-
24	UTTAR PRADESH	-	-	-	-	-	-	-	-	-
25	WEST BENGAL	-	-	-	-	-	-	-	-	-
26	A & N ISLANDS	3	12	15	2	8	10	66.67	66.67	66.67
27	CHANDIGARH	-	-	-	-	-	-	-	-	-
28	DADRA & NAGAR HAVELI	-	-	-	-	-	-	-	-	-
29	DAMAN & DIU	-	-	-	-	-	-	-	-	-
30	DELHI	458	651	1109	274	313	587	59.83	48.08	52.93
31	LAKSHADWEEP	-	-	-	-	-	-	-	-	-
32	PONDICHERRY	13	16	29	8	10	18	61.54	62.50	62.07
	INDIA	86443	120713	207156	45461	65791	111252	52.59	54.50	53.70

1 Data relates to 1990-91

2 Data relates to 1988-89

TABLE 9.28 : POST MATRIC DIPLOMA/CERTIFICATE (NOT LEADING TO DEGREE)-NON -AFFILIATED
ENGINEERING/TECHNOLOGY /ARCHITECTURE
YEAR 1991 - 92

S.no.	State/UTs	Number Appeared			Number Passed			Pass Percentage		
		Boys	Girls	Total	Boys	Girls	Total	Boys	Girls	Total
1	2	3	4	5	6	7	8	9	10	11
1	ANDHRA PRADESH	20358	3614	23972	11698	2145	13843	57.46	59.35	57.75
2	ARUNACHAL PRADESH	-	-	-	-	-	-	-	-	-
3	ASSAM	2886	225	3111	1795	172	1967	62.20	76.44	63.23
4	BIHAR	-	-	-	-	-	-	-	-	-
5	GOA	2785	161	2946	1548	311	1659	55.58	68.94	56.31
6	GUJARAT	3195	105	3300	1607	61	1668	50.30	58.10	50.55
7	HARYANA	13690	3667	17357	9673	1566	11239	70.66	42.71	64.75
8	HIMACHAL PRADESH	1768	1027	2795	1266	949	2215	71.61	92.41	79.25
9	JAMMU & KASHMIR	2858	910	3768	1459	616	2075	51.05	67.69	55.07
10	KARNATAKA	-	-	-	-	-	-	-	-	-
11	KERALA	3196	1157	4353	2188	823	3011	68.46	71.13	69.17
12	MADHYA PRADESH	-	-	-	-	-	-	-	-	-
13	MAHARASHTRA	-	-	-	-	-	-	-	-	-
14	MANIPUR	93	21	114	75	15	90	80.65	71.43	78.95
15	MEGHALAYA	91	14	105	30	6	36	32.97	42.86	34.29
16	MIZORAM	-	-	-	-	-	-	-	-	-
17	NAGALAND	-	-	-	-	-	-	-	-	-
18	ORISSA	4801	274	5075	4570	233	4803	95.19	85.04	94.64
19	PUNJAB	5138	272	5410	3437	99	3536	66.89	36.40	64.36
20	RAJASTHAN	7260	673	7933	5066	554	5620	69.78	82.32	70.84
21	SIKKIM	-	-	-	-	-	-	-	-	-
22	TAMIL NADU	13690	2505	16195	6690	1494	8184	48.87	59.64	50.53
23	TRIPURA	-	-	-	-	-	-	-	-	-
24	UTTAR PRADESH	-	-	-	-	-	-	-	-	-
25	WEST BENGAL	-	-	-	-	-	-	-	-	-
26	A & N ISLANDS	87	33	120	57	20	77	65.52	60.61	64.17
27	CHANDIGARH	-	-	-	-	-	-	-	-	-
28	DADRA & NAGAR HAVELI	-	-	-	-	-	-	-	-	-
29	DAMAN & DIU	140	18	158	108	3	111	77.14	16.67	70.25
30	DELHI	6487	1924	8411	4718	1657	6375	72.73	86.12	75.79
31	LAKSHADWEEP	-	-	-	-	-	-	-	-	-
32	PONDICHERRY	111	108	219	56	44	100	50.45	40.74	45.66
	INDIA	88634	16708	105342	56041	10568	66609	63.23	63.25	63.23

@ Data relates to 1990-91
\$ Data relates to 1988-89

TABLE 9.29 : POST MATRIC DIPLOMA/CERTIFICATE (NOT LEADING TO DEGREE)-NON -AFFILIATED
MEDICINE/NURSING/PHARMACY/DENTISTRY
YEAR 1991 - 92

S.no.	State/UTs	Number Appeared			Number Passed			Pass Percentage		
		Boys	Girls	Total	Boys	Girls	Total	Boys	Girls	Total
1	2	3	4	5	6	7	8	9	10	11
1	ANDHRA PRADESH	-	-	-	-	-	-	-	-	-
2	ARUNACHAL PRADESH	-	-	-	-	-	-	-	-	-
3	ASSAM	-	-	-	-	-	-	-	-	-
4	BIHAR	-	-	-	-	-	-	-	-	-
5	GOA	15	50	65	12	48	60	80.00	96.00	92.31
6	GUJARAT	67	538	605	58	358	416	86.57	66.54	68.76
7	HARYANA	713	599	1312	268	495	763	37.59	82.64	58.16
8	HIMACHAL PRADESH	-	-	-	-	-	-	-	-	-
9	JAMMU & KASHMIR	77	42	119	66	25	91	85.71	59.52	76.47
10	KARNATAKA	-	-	-	-	-	-	-	-	-
11	KERALA	351	1808	2159	99	1470	1569	28.21	81.31	72.67
12	MADHYA PRADESH	-	-	-	-	-	-	-	-	-
13	MAHARASHTRA	156	77	233	98	62	160	62.82	80.52	68.67
14	MANIPUR	-	82	82	-	74	74	-	90.24	90.
15	MEGHALAYA	-	-	-	-	-	-	-	-	-
16	MIZORAM	-	-	-	-	-	-	-	-	-
17	NAGALAND	-	-	-	-	-	-	-	-	-
18	ORISSA	-	-	-	-	-	-	-	-	-
19	PUNJAB	208	1162	1370	119	981	1100	57.21	84.42	80.29
20	RAJASTHAN	661	1635	2296	508	1482	1990	76.85	90.64	86.67
21	SIKKIM	-	-	-	-	-	-	-	-	-
22	TAMIL NADU	310	1310	1620	296	1216	1512	95.48	92.82	93.33
23	TRIPURA	-	-	-	-	-	-	-	-	-
24	UTTAR PRADESH	-	-	-	-	-	-	-	-	-
25	WEST BENGAL	-	-	-	-	-	-	-	-	-
26	A & N ISLANDS	-	-	-	-	-	-	-	-	-
27	CHANDIGARH	-	-	-	-	-	-	-	-	-
28	DADRA & NAGAR HAVELI	-	-	-	-	-	-	-	-	-
29	DAHAN & DIU	-	-	-	-	-	-	-	-	-
30	DELHI	168	77	245	102	70	172	60.71	90.91	70.20
31	LAKSHADWEEP	-	-	-	-	-	-	-	-	-
32	PONDICHERRY	-	52	52	-	48	48	-	92.31	92.
	INDIA	2726	7432	10158	1626	6329	7955	59.65	85.16	78.31

@ Data relates to 1990-91

\$ Data relates to 1988-89

TABLE 9.30 : POST MATRIC DIPLOMA/CERTIFICATE (NOT LEADING TO DEGREE)-NON -AFFILIATED
OTHERS (INCLUDING EDUCATION, MUSIC & FINE ARTS, ORIENTAL STUDIES etc.
YEAR 1991 - 92

S.no.	State/UTs	Number Appeared			Number Passed			Pass Percentage		
		Boys	Girls	Total	Boys	Girls	Total	Boys	Girls	Total
1	2	3	4	5	6	7	8	9	10	11
1	ANDHRA PRADESH	3724	723	4447	3285	552	3837	88.21	76.35	86.28
2	ARUNACHAL PRADESH	-	-	-	-	-	-	-	-	-
3	ASSAM	1670	438	2108	706	184	890	42.28	42.01	42.22
4	BIHAR	23	9	32	23	9	32	100.00	100.00	100.00
5	GOA	27	96	123	27	89	116	100.00	92.71	94.31
6	GUJARAT	13313	1191	14504	10010	904	10914	75.19	75.90	75.25
7	HARYANA	39	94	133	11	46	57	28.21	48.94	42.86
8	HIMACHAL PRADESH	-	-	-	-	-	-	-	-	-
9	JAMMU & KASHMIR	297	167	464	214	102	316	72.05	61.08	68.10
10	KARNATAKA	7510	7530	15040	5382	5005	10387	71.66	66.47	69.06
11	KERALA	3087	3370	6457	2657	2949	5606	86.07	87.51	86.82
12	MADHYA PRADESH	-	-	-	-	-	-	-	-	-
13	MAHARASHTRA	4	3	7	2	3	5	50.00	100.00	71.43
14	MANIPUR	75	50	125	51	37	88	68.00	74.00	70.40
15	MEGHALAYA	159	200	359	130	185	315	81.76	92.50	87.74
16	MIZORAM	-	-	-	-	-	-	-	-	-
17	NAGALAND	42	8	50	41	8	49	97.62	100.00	98.00
18	ORISSA	1559	1352	2911	1520	1255	2775	97.50	92.83	95.33
19	PUNJAB	382	635	1017	310	488	798	81.15	76.85	78.47
20	RAJASTHAN	2988	1978	4966	2368	1645	4013	79.25	83.16	80.81
21	SIKKIM	-	-	-	-	-	-	-	-	-
22	TAMIL NADU	18764	3196	21960	13502	2327	15829	71.96	72.81	72.08
23	TRIPURA	-	-	-	-	-	-	-	-	-
24	UTTAR PRADESH	988	1121	2109	847	929	1776	85.73	82.87	84.21
25	WEST BENGAL	-	-	-	-	-	-	-	-	-
26	A & N ISLANDS	-	-	-	-	-	-	-	-	-
27	CHANDIGARH	-	-	-	-	-	-	-	-	-
28	DADRA & NAGAR HAVELI	-	-	-	-	-	-	-	-	-
29	DAMAN & DIU	-	-	-	-	-	-	-	-	-
30	DELHI	867	915	1782	631	743	1374	72.78	81.20	77.10
31	LAKSHADWEEP	-	-	-	-	-	-	-	-	-
32	PONDICHERRY	-	-	-	-	-	-	-	-	-
INDIA		55518	23076	78594	41717	17460	59177	75.14	75.66	75.29

@ Data relates to 1990-91
\$ Data relates to 1988-89

NIEPA DC



D09470

LIBRARY & DOCUMENTATION CENTRE
National Institute of Educational
Planning and Administration.
17-B, Sri Aurobindo Marg,
New Delhi-110016
DOC, No D-9470
Date 09-04-97